

WKC - 100
User Guide
(v 1.0)

Caution

As this equipment undergone EMC registration for household purpose, this product can be used in any area including residential area.

FCC Compliance Statement

Caution : Any changes or modifications in construction of this device which are not expressly approved the party responsible for compliance could void the user's authority to operate the equipment.

NOTE : This equipment has been tested and found to comply with the limits for a Class B digital device, pursuant to part 15 of the FCC Rules. These limits are designed to provide reasonable protection against harmful interference in a residential installation. This equipment generates, uses and can radiate radio frequency energy and, if not installed and used in accordance with the instructions, may cause harmful interference to radio communications, However, there is no guarantee that interference will not occur in a particular installation. If this equipment does cause harmful interference to radio or television reception, which can be determined by turning the equipment off and on, the user is encouraged to try to correct the interference by one or more of the following measures:

- Reorient or relocate the receiving antenna.
- Increase the separation between the equipment and receiver.
- Connect the equipment into an outlet on a circuit different from that to which the receiver is connected.
- Consult the dealer or an experienced radio/TV technician for help.

Caution

Change or Modifications not expressly approved by the party responsible for compliance could void the users authority to operate the equipment

Warning

1. Danger of explosion if battery is incorrectly replaced. Replace only with the same or equivalent type. Disposal of used batteries according to the general recommendations against the environmental pollution.
2. Do not throw the batteries into a fire, and do not heat, short-circuit or attempt to disassemble the batteries.

Important Safeguards

1. WKC-100 is for indoor use. It is not weatherproof. Use WKC-100 with referring to its environmental specifications (Temperature & Humidity). To clean the WKC-100, gently wipe the outside with a clean dry cloth.
2. Be cautious not to cause electric damages to WKC-100 and use proper adapter provided by Webgate Inc.
3. Be careful not to throw or drop the WKC-100. Physical shocks may harm the product.
4. WKC-100 can hurt human beings if you throw it to them or hit on them. When installing WKC-100, be cautious to locate on safe places where children are unreachable
5. If WKC-100 does not operate properly, please contact the closest WEBGATE distributor for after sales service. Tampering or disassembling the product will void the warranty
6. Security surveillance laws may differ for each country. Therefore, please contact the local region first to avoid any surveillance law violations.

Contents

1. INTRODUCTION	1
1.1. WKC-100.....	1
1.2. Front View.....	2
1.3. Rear View.....	2
2. CONNECTION AND CONFIGURATION	3
2.1. Connection between keyboard and dvr.....	3
2.1.1. Connection between Keyboard and Junction-Box (J-Box).....	3
2.1.2. Connection between Junction Box(J-Box) and DVR COM Port.....	4
2.1.3. Connection between Several DVRs and One Junction Box(J-Box).....	5
2.1.4. Connection between Several DVRs with Keyboard Bypass.....	6
2.2. Connection between DVR and speed dome camera.....	9
2.3. Connection between Keyboard and speed dome camera.....	10
2.4. DVR Configuration.....	11
2.4.1. Configuring Serial Port.....	11
2.4.1.1. When COM2 is used to communicate with the keyboard.....	11
2.4.1.2. When COM4 is used to communicate with the keyboard.....	12
2.4.2. Configuring Camera Control Address of DVR.....	13
2.4.3. Configuring Camera PTZ Port of DVR.....	14
2.4.4. Configuring Keyboard Bypass with Several DVRs.....	15
2.5. Keyboard configuration.....	16
2.6. INstallation Example.....	17
2.6.1. Basic Installation Diagram.....	17
2.6.1.1. Installation between Keyboard and Speed Dome Camera.....	17
2.6.1.2. Installation between Keyboard, DVR, and Speed Dome Camera.....	18
2.6.1.3. Installation between One Keyboard and Several DVRs.....	22
3. KEYBOARD OPERATION	29
3.1. Menu key.....	29
3.2. DVR Configuration key.....	30
3.3. Speed Dome camera (PTZ) configuration key.....	33
3.4. Keyboard menu operation key.....	34
3.4.1. Basic Operation.....	34
3.4.2. Configuration.....	36
3.4.3. Operation.....	42
3.4.3.1. Selection of dome camera (Dome Camera ID).....	42
3.4.3.2. Selection of DVR (DVR ID).....	42

1. Introduction

1.1. WKC-100

WKC-100 is control device for eDVR and PTZ supported camera attached at eDVR, which includes channel selection, playback, and PTZ control button for eDVR. WKC-100 is basically designed for controlling SPD1800/2600 provided by WebGate.

Key Features

- Information Status via LCD Screen
- Streamline Design
- Controlling All Functions of DVR
- Maximum 16 units of DVR Connection
- Maximum 64(Simplex), 256(Half duplex) units of Camera Connection
- SPD1800/2600 Controlling via eDVR

1.2. FRONT VIEW

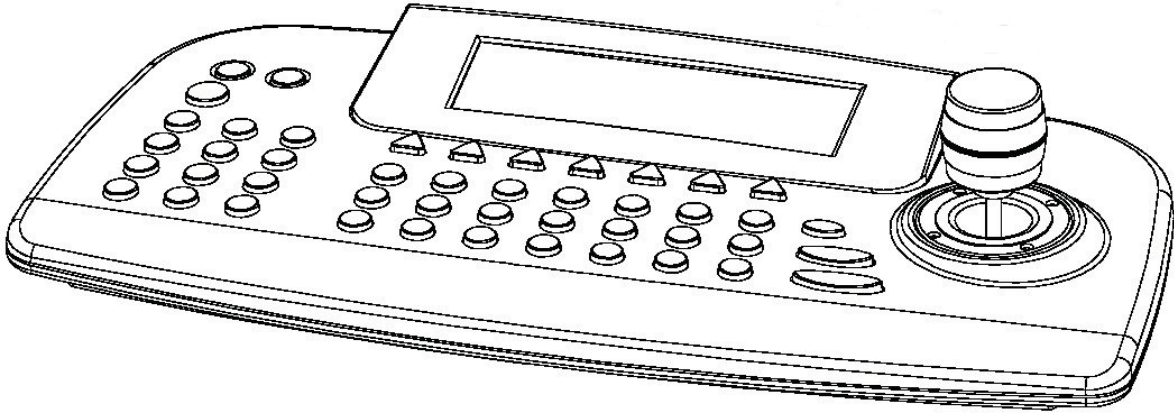

1.3. REAR VIEW

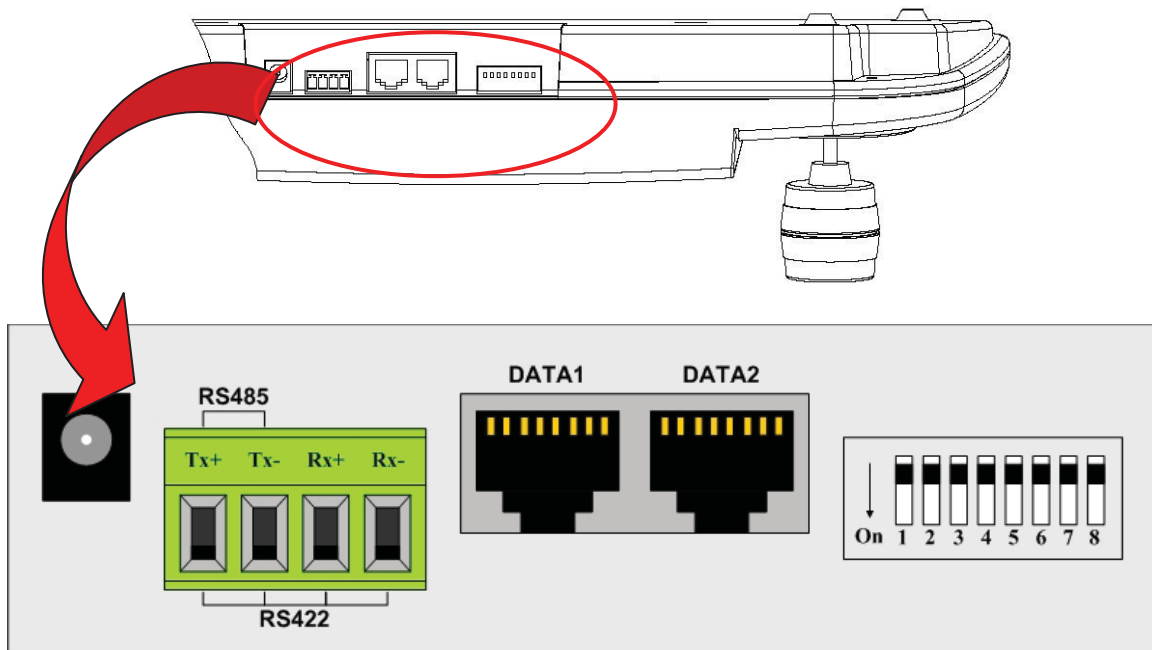

2. Connection and Configuration

2.1. CONNECTION BETWEEN KEYBOARD AND DVR

eDVR DS1600 series provided by Webgate has two communication ports for RS-422/485, one is for terminal block and the other is for RJ-45 jack, which are available for two ports to communicate with keyboard.

2.1.1. Connection between Keyboard and Junction-Box (J-Box)

Plug in power supply to the J-Box and make a connection between DATA1 port of Keyboard and J-Box via direct cable.

➔ It is not necessary to plug in power supply for Keyboard since J-Box is already connected on 12V power.

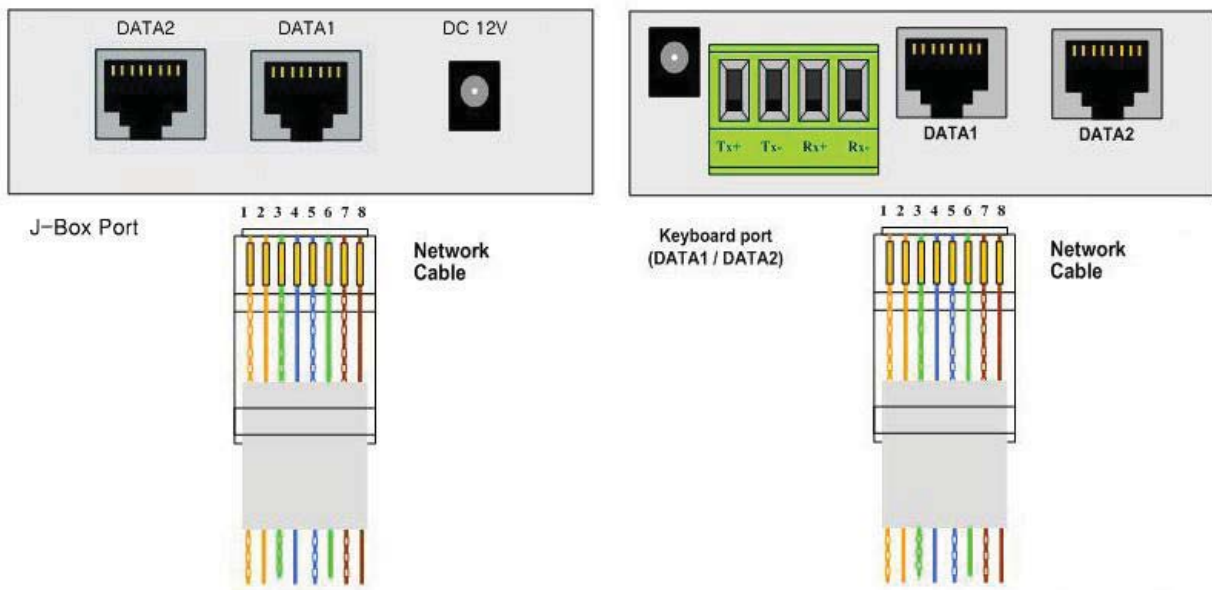

Connection between Keyboard and J-Box

2.1.2. Connection between Junction Box(J-Box) and DVR COM Port

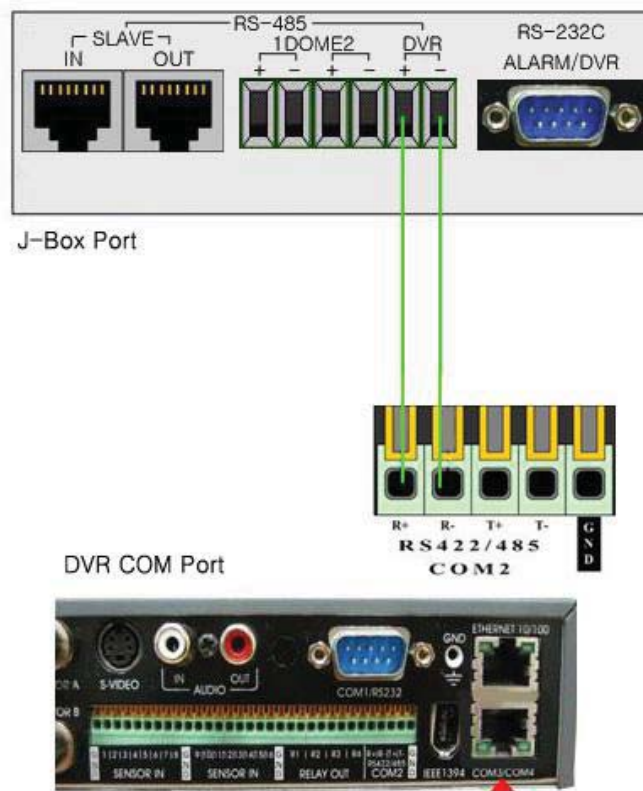
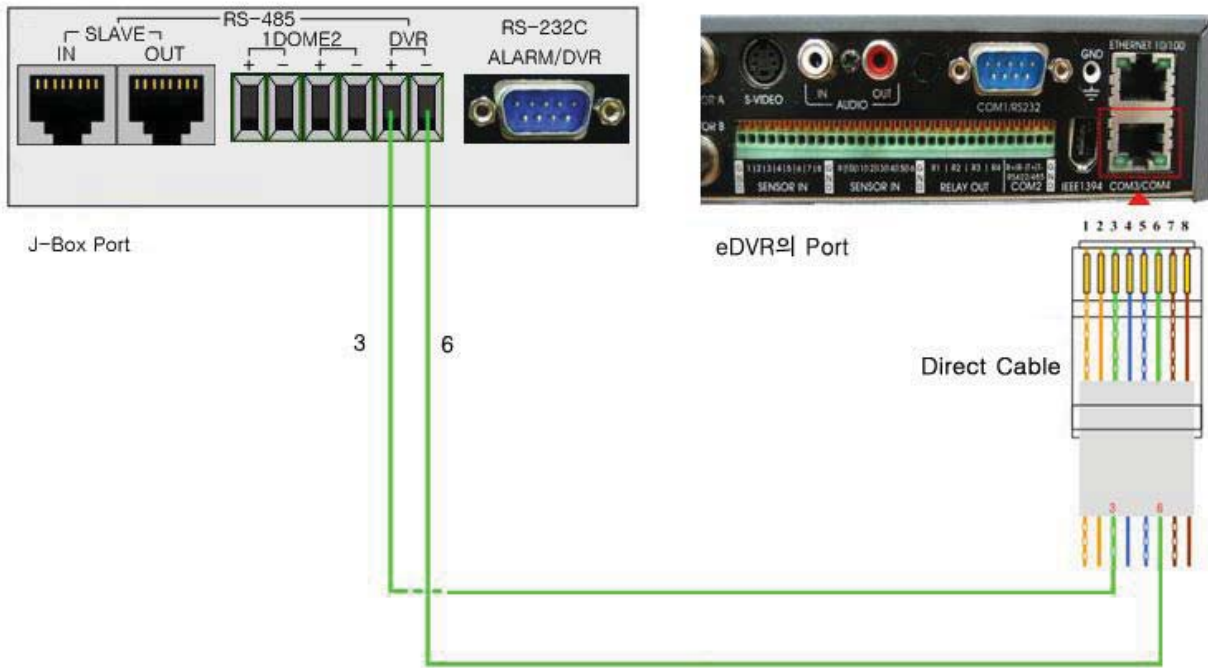

2.1.3. Connection between Several DVRs and One Junction Box(J-Box)

In case of connecting several DVRs to one Junction Box, + & - can be jumped to other DVRs shown as below figure. In case of connecting to COM3/4 port of DVR, please follow the same way as jumping a cable.

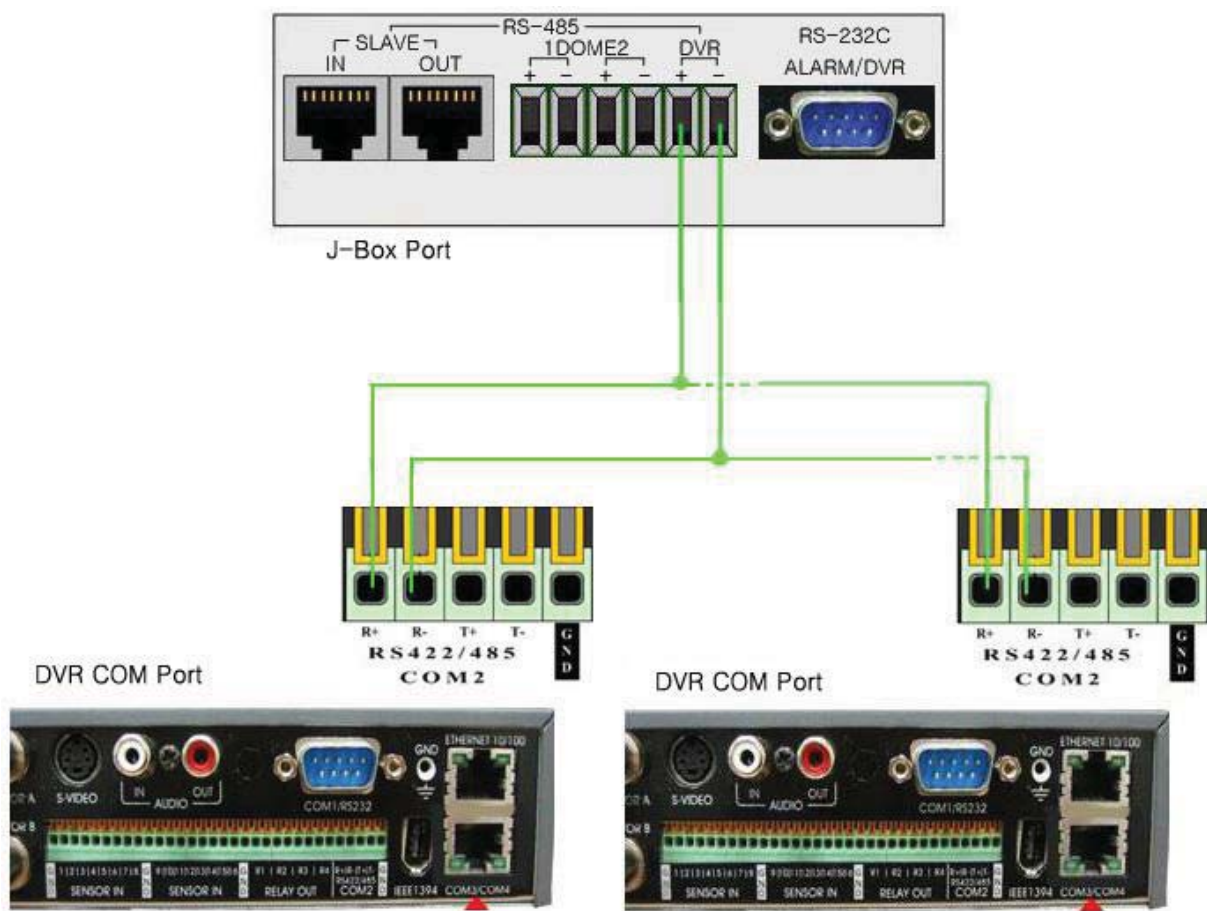

Connection between Several DVRs and One J-Box

2.1.4. Connection between Several DVRs with Keyboard Bypass

Connect COM1 RS-232 among each DVRs.

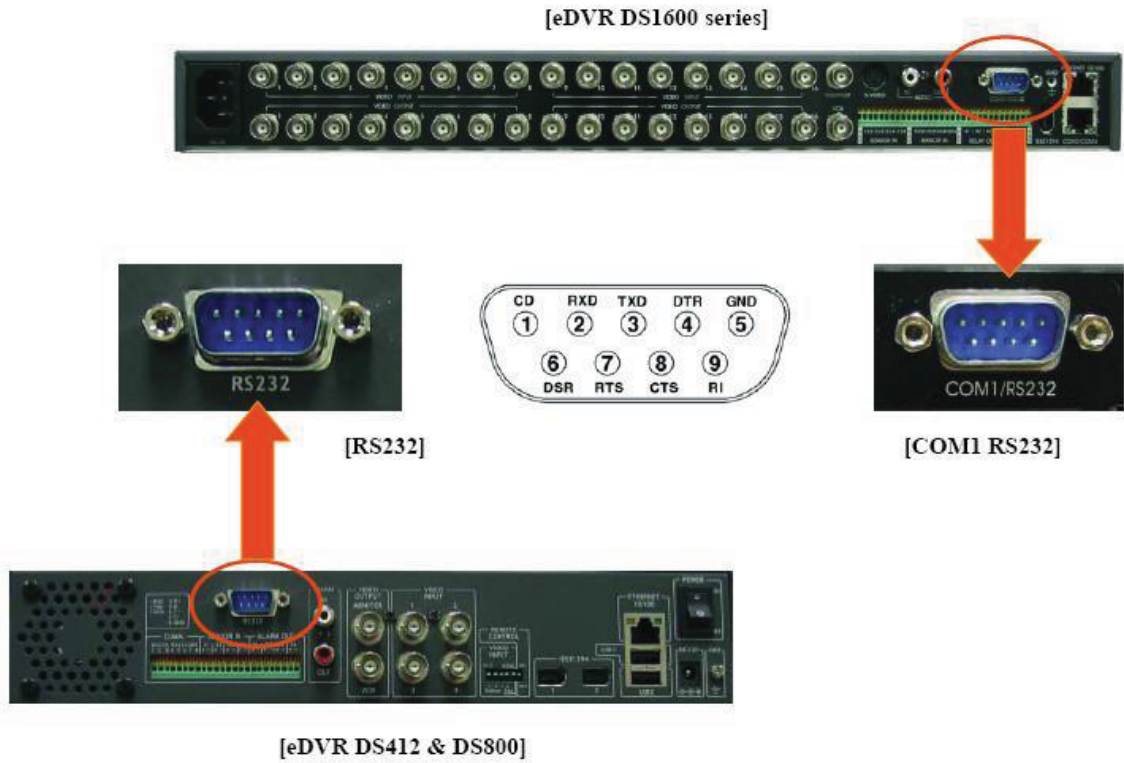

☞ How to Utilize Standard Network Cable

If a standard Cat 5 network cable is used, assume each wire's function of 'COM4 RS422/485 port of DS1600' from the color. However it is necessary to confirm the wire position if the network cable has the same arrangement as below figure.

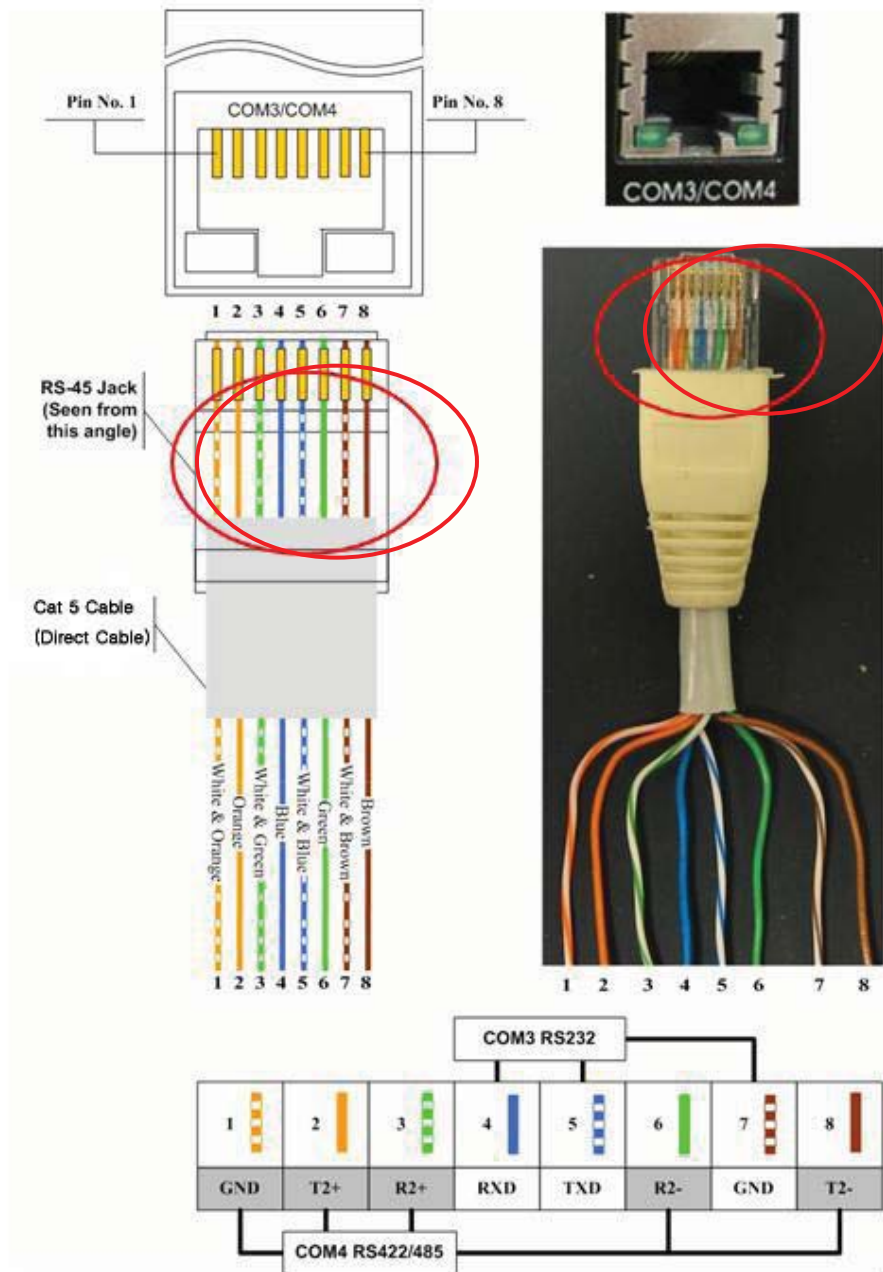

☞ How to Utilize Keyboard Pin-Map

The below figure shows pin map functions for DATA1 & DATA2.

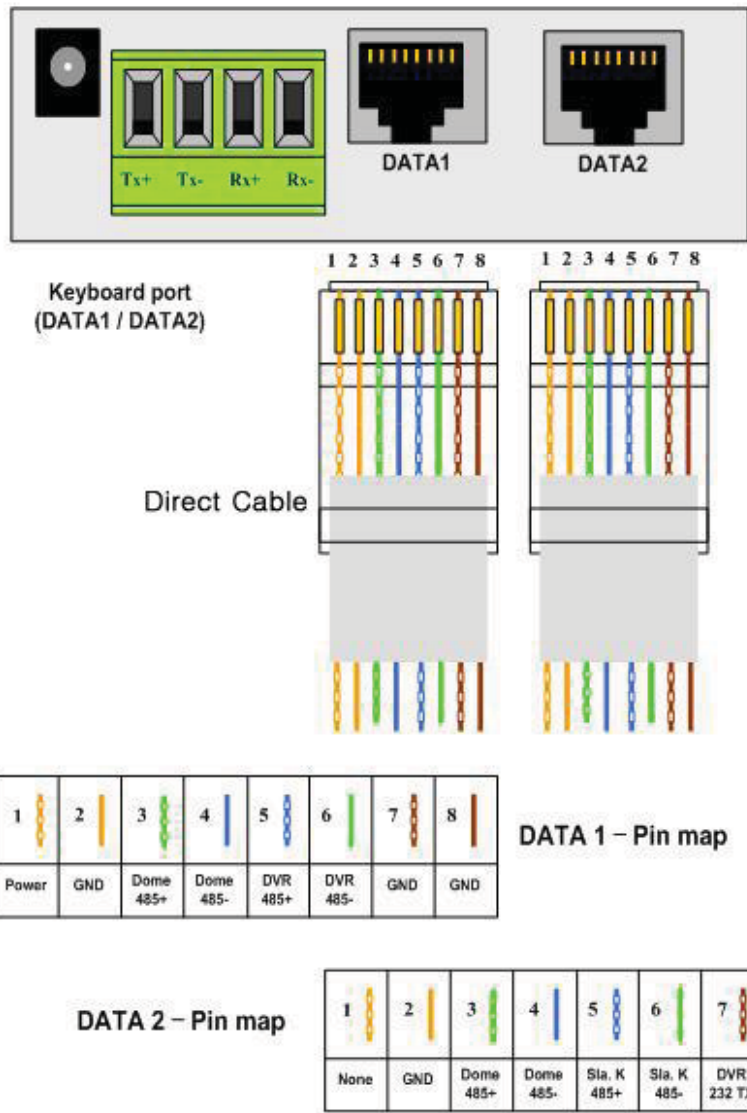

2.2. CONNECTION BETWEEN DVR AND SPEED DOME CAMERA

Make a connection between RX+, RX- of Speed Dome Camera and R+, R- of DVR COM2 port. Please refer to the user guide of eDVR & SPD1800/2600 for more in details.

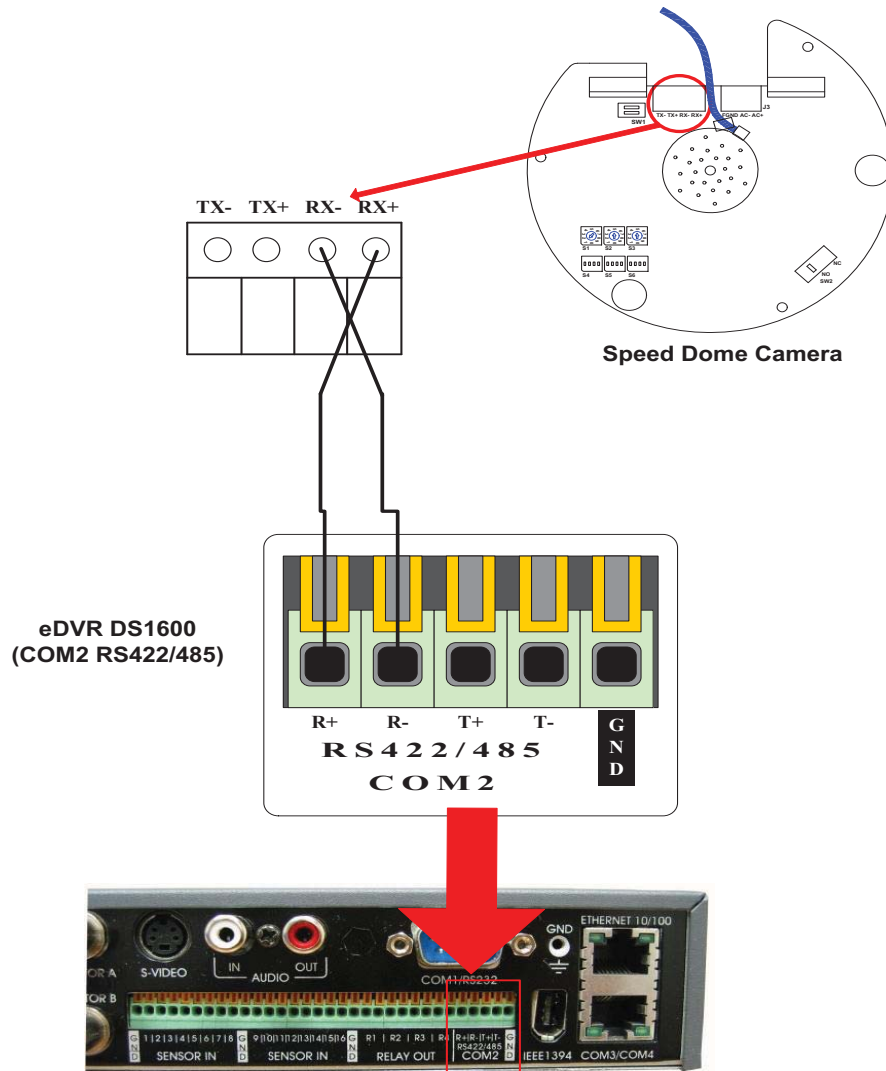

2.3. CONNECTION BETWEEN KEYBOARD AND SPEED DOME CAMERA

Make a connection between RS485 port of keyboard (WKC-100) and speed dome camera (SPD1800/2600) shown as below figure. Please refer to the user guide of SPD1800&2600 for more in details.

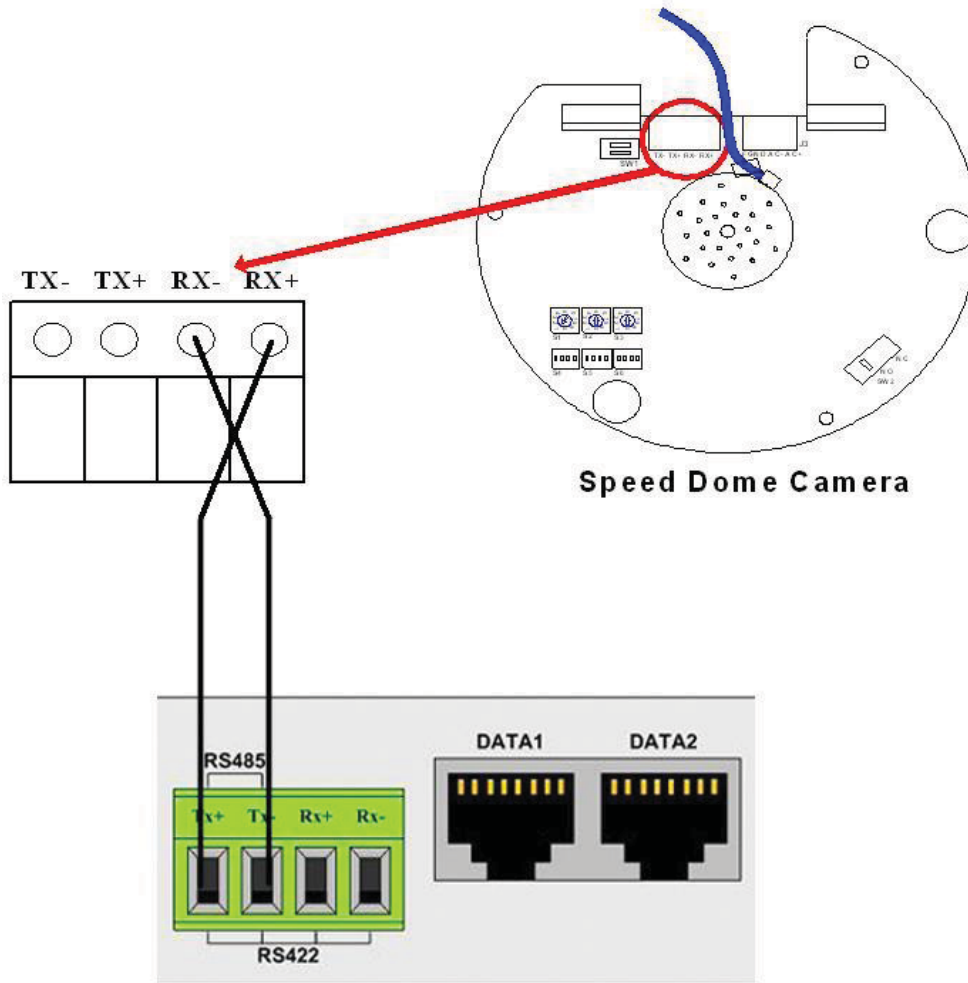

2.4. DVR CONFIGURATION

Please configure DVR followed as:

2.4.1. Configuring Serial Port

2.4.1.1. When COM2 is used to communicate with the keyboard

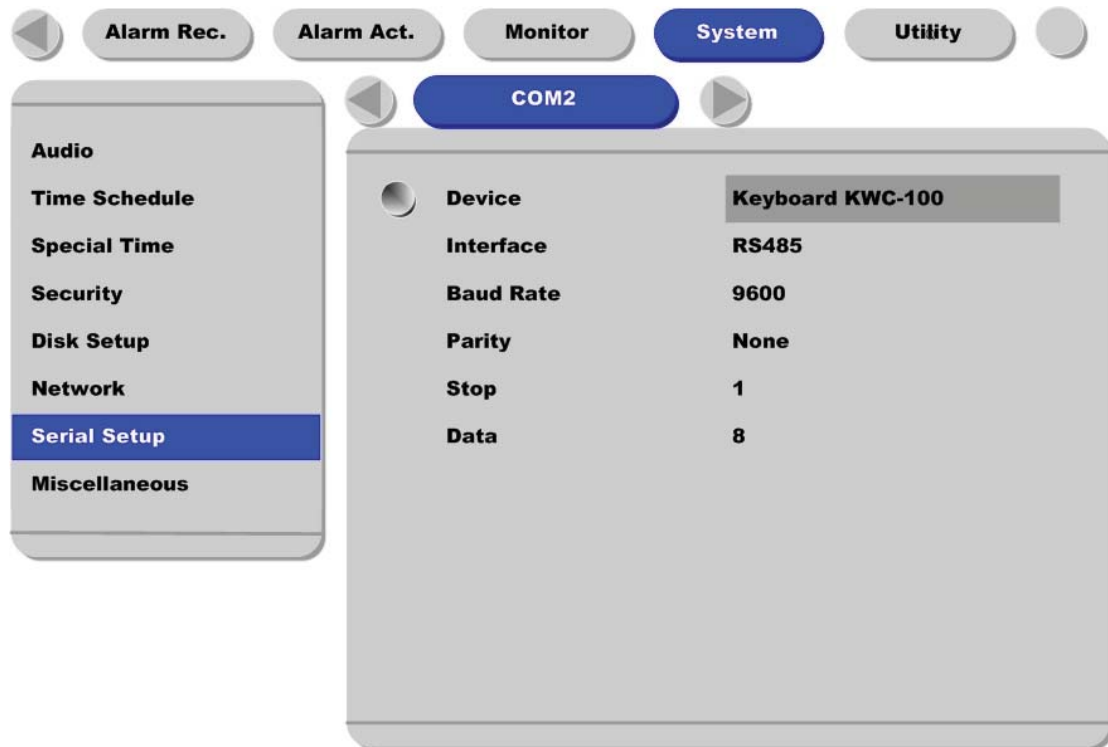

- Press "MENU" button
- Go to [SYSTEM] -> [SERIAL SETUP] -> [COM2 RS422/485] menu.
- Select 'Device' as 'Keyboard WKC-100'.
- Set 'Baud Rate' as '9600'.
- Set 'Parity' as 'None'.
- Set 'Stop' as '1'.
- Set 'Data' as '8'.

2.4.1.2. When COM4 is used to communicate with the keyboard

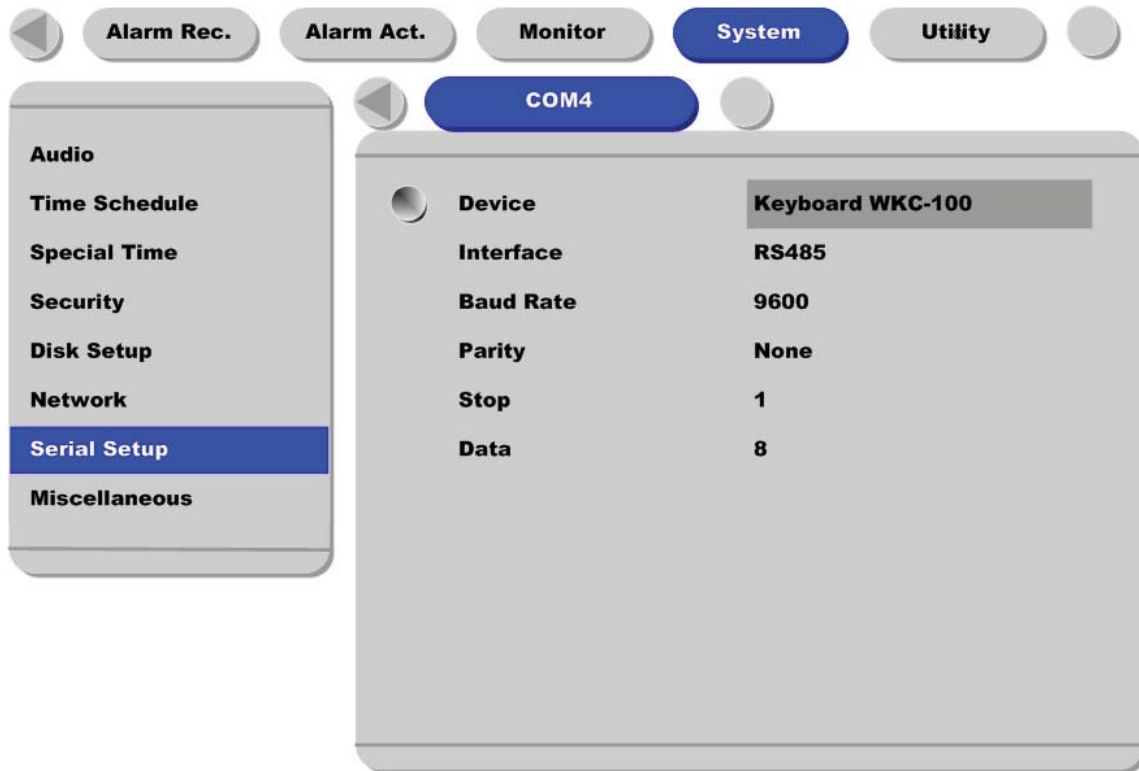

- Press “MENU” button
- Go to [SYSTEM] -> [SERIAL SETUP] -> [COM4 RS422/485] menu.
- Select ‘Device’ as ‘Keyboard WKC-100’.
- Set ‘Baud Rate’ as ‘9600’.
- Set ‘Parity’ as ‘None’.
- Set ‘Stop’ as ‘1’.
- Set ‘Data’ as ‘8’.

2.4.2. Configuring Camera Control Address of DVR

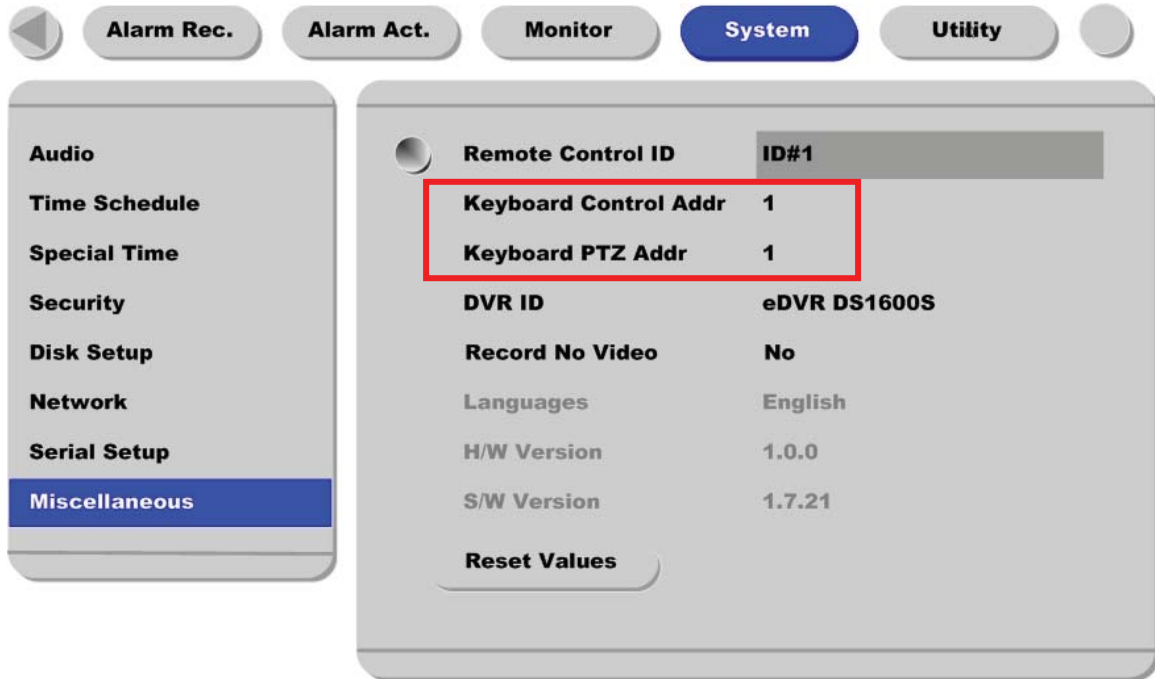

- ◆ **Keyboard Control Addr**
This is to set address of DVR for communication with keyboard.
- ◆ **Keyboard PTZ Addr**
This is to set the address of video channel of No. 1 for serial communication with keyboard. From the Ch 2, the sequential numbers are automatically assigned by DVR. In this DVR, for example, Ch2 will have control address 2, Ch3 will have the control address 3, etc

2.4.3. Configuring Camera PTZ Port of DVR

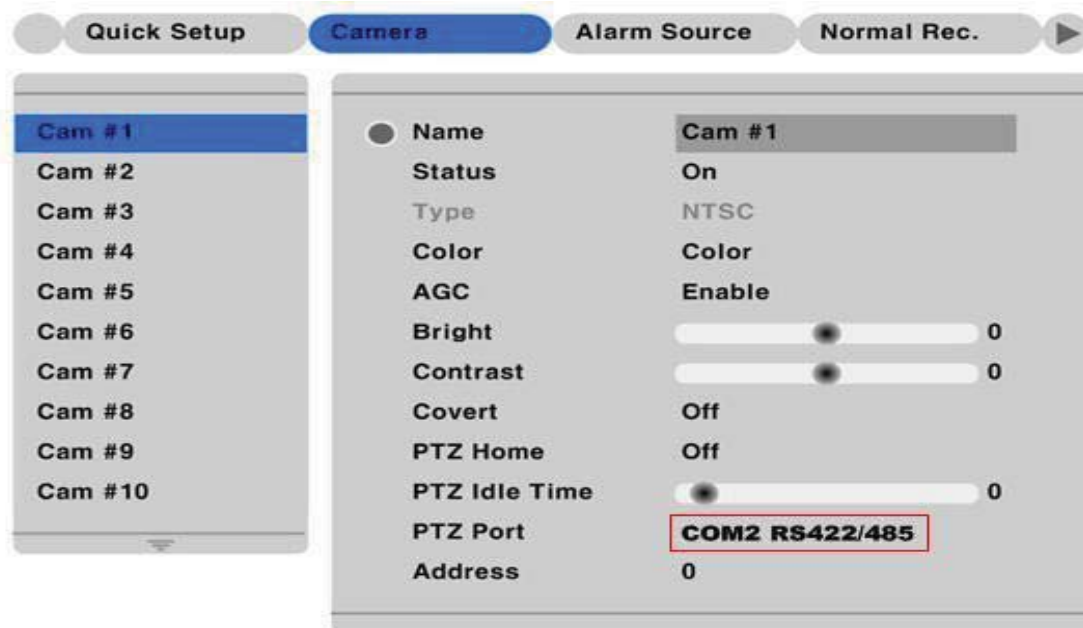

- Press "MENU" button
- Go to [Camera] -> [Channel #] menu
- Select 'Status' as 'ON'
- Select 'Type' as 'NTSC' or 'PAL'
- Select 'Color' as 'Color' or 'B/W'
- Select 'AGC' as 'Enable' or 'Disable'
- Adjust 'Brightness'
- Adjust 'Contrast'
- Set 'PTZ Port' as the connected with camera
- Set 'Address' as same value as on the camera

2.4.4. Configuring Keyboard Bypass with Several DVRs

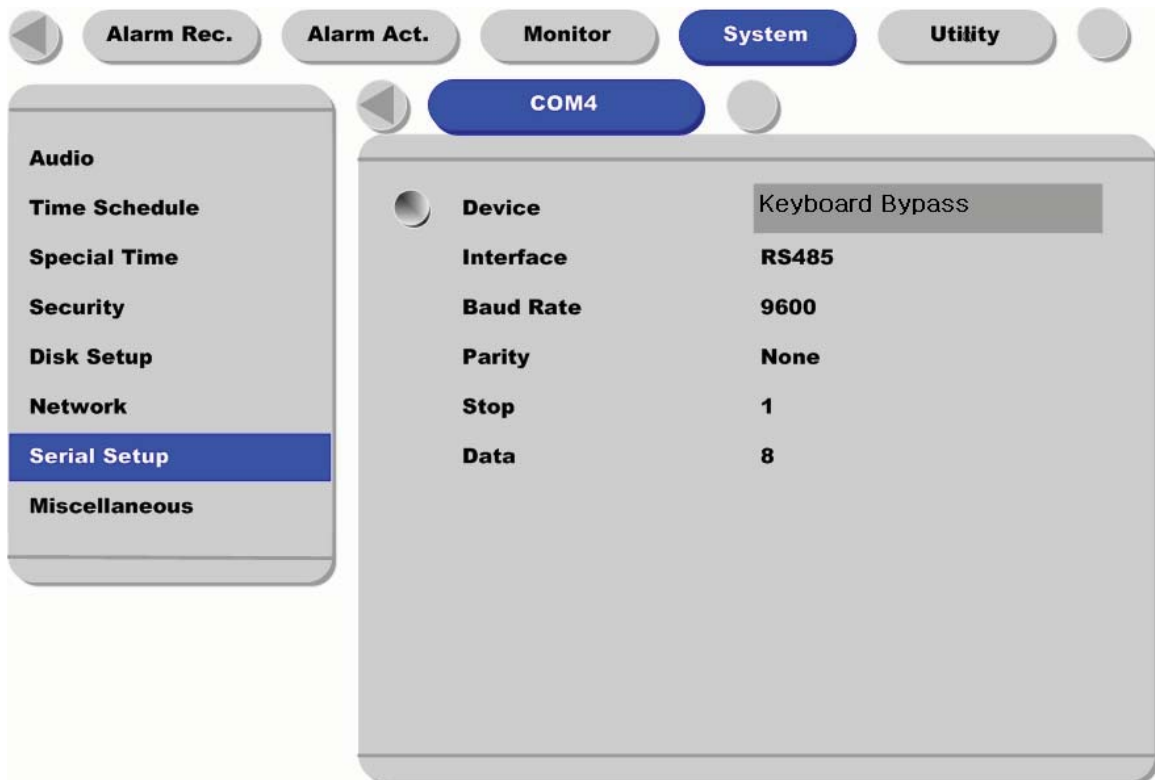

- **Keyboard Bypass**

In case of connecting to two DVRs with one keyboard, connect each two DVR and should configure 'Keyboard Bypass' at the DVR connected to the keyboard. Select "Keyboard WKC-100" for COM port at another DVR, which is not connected to the keyboard.



COM3 of 1st DVR : WKC-100
COM4 of 1st DVR : Keyboard Bypass
COM1 of 2nd DVR : WKC-100

2.5. KEYBOARD CONFIGURATION

Set the DIP switch of the keyboard “On’ only for #1 shown as below figure.

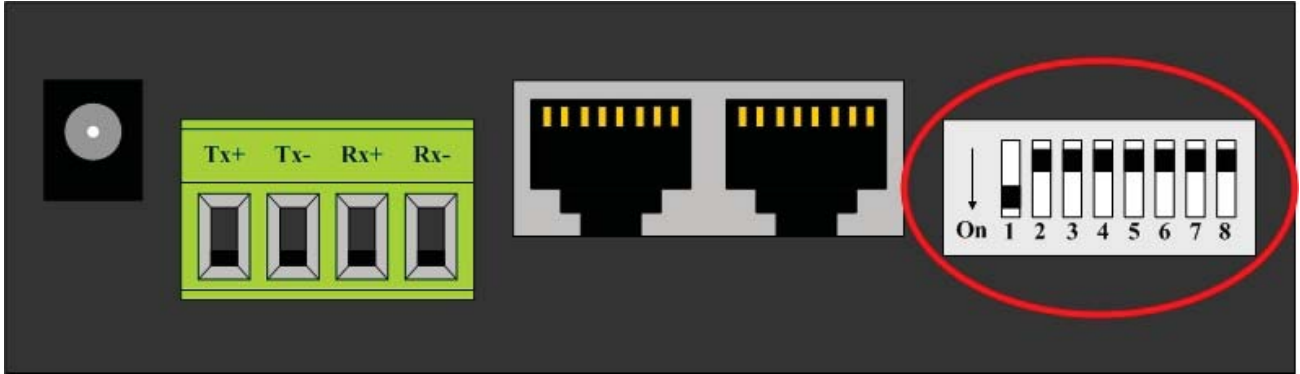

Each DIP Switch Functions

Switch	Description
S1	RS-485 & Dome 1 Port Termination
S2	RS-422 Port Termination
S3	Dome 2 Port Termination
S4	DVR Port Termination
S5	Salve Port Termination
S6	Reserved
S7	Reserved
S8	Off-Master / On-Slave

When the keyboard is powered, it requires entering password to operate. The password is '9999'. Press the number keys followed by 'Enter' key as below.



2.6. INSTALLATION EXAMPLE

2.6.1. Basic Installation Diagram

2.6.1.1. Installation between Keyboard and Speed Dome Camera

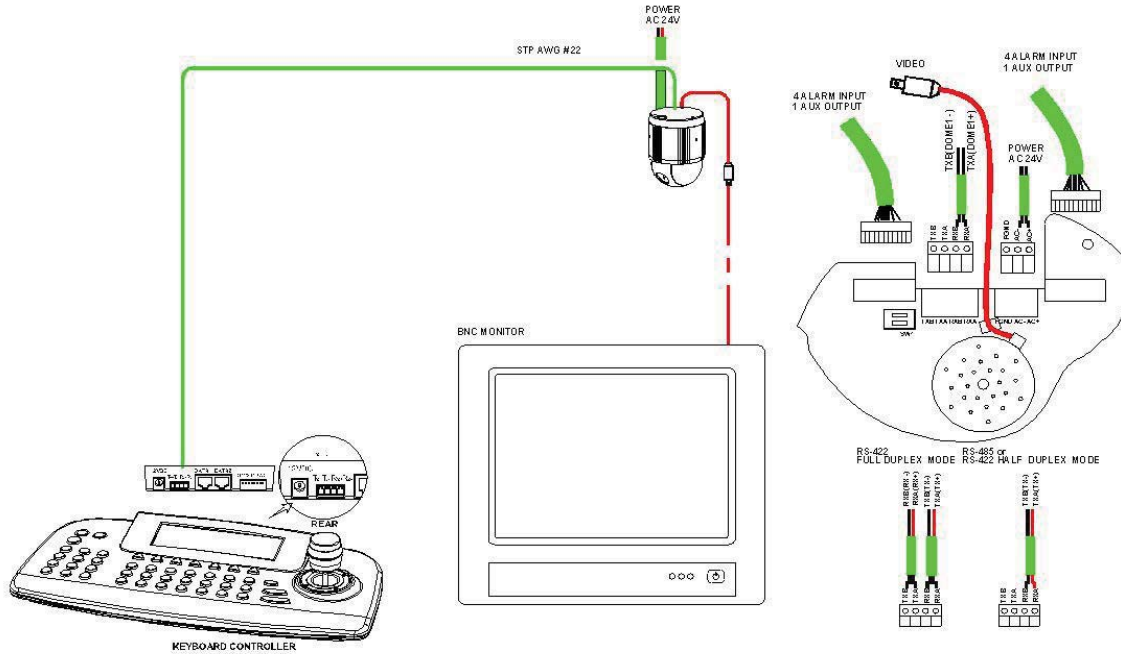

Make a connection between TX+, TX- of Keyboard RS485 port and RX+, RX- of Speed Dome Camera (TX+ → RX+ , TX- → RX-)

Connect “Video-Out” of Speed Dome Camera to “Video-In” of Monitor.

Pressing numeric key + SYS key makes controlling mode for the selected Speed Dome Camera at the LCD screen of keyboard.

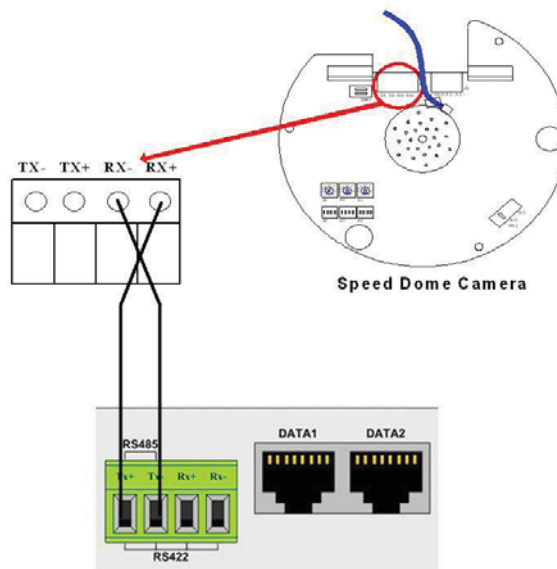

2.6.1.2. Installation between Keyboard, DVR, and Speed Dome Camera

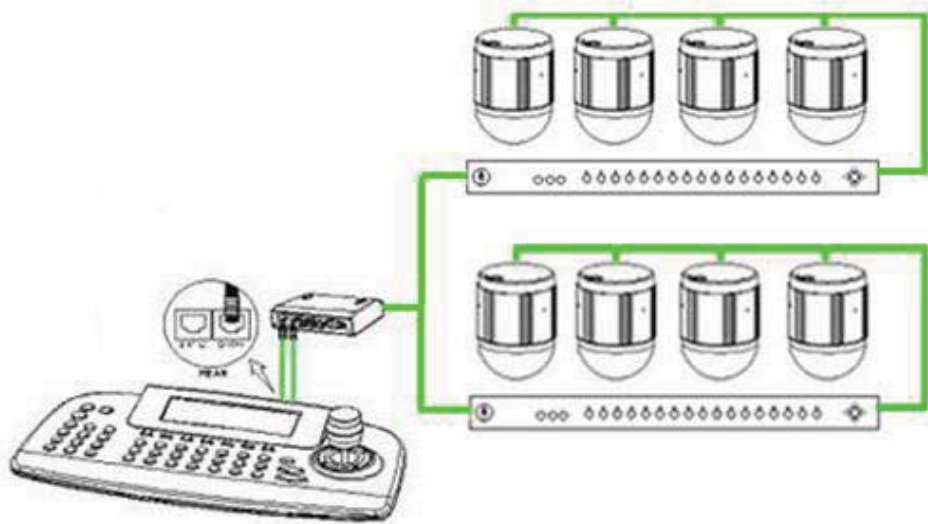

① Connect RS-485 port of Speed Dome Camera to COM port (RS-485) of DVR shown as below figure.

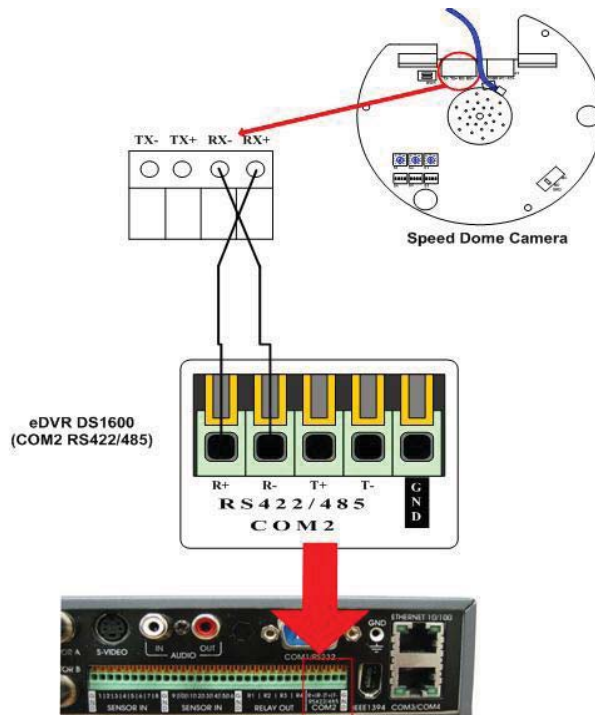

② Make a connection between DATA1 of keyboard and COM port of DVR1 using Ethernet line.

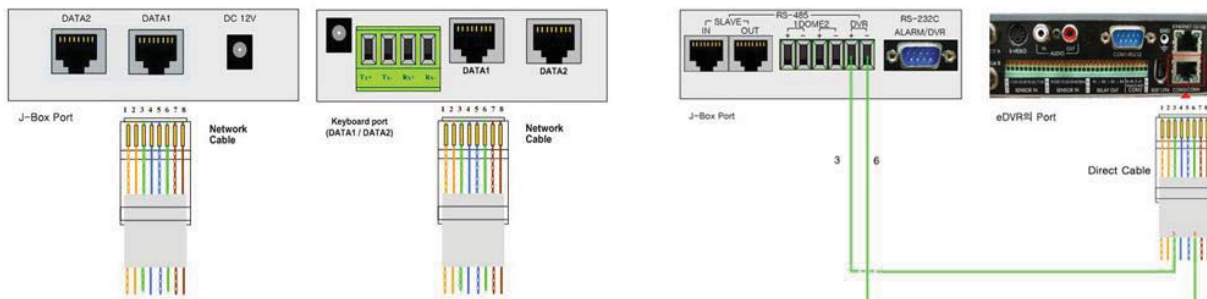

<Note>

1. In case of controlling several DVRs with only one keyboard, Jump Box is necessary. Connect keyboard terminal to “In” port of Jump Box and each DVR to “Out” port of Jump Box.
2. Then, ‘Keyboard Control Address’ of each DVR should have different value ([SYSTEM] -> [Miscellaneous])

DVR Number	DVR1	DVR2	DVR3	DVR4
Keyboard Control Address	1	2	3	4
Keyboard PTZ Address	1	1	1	1

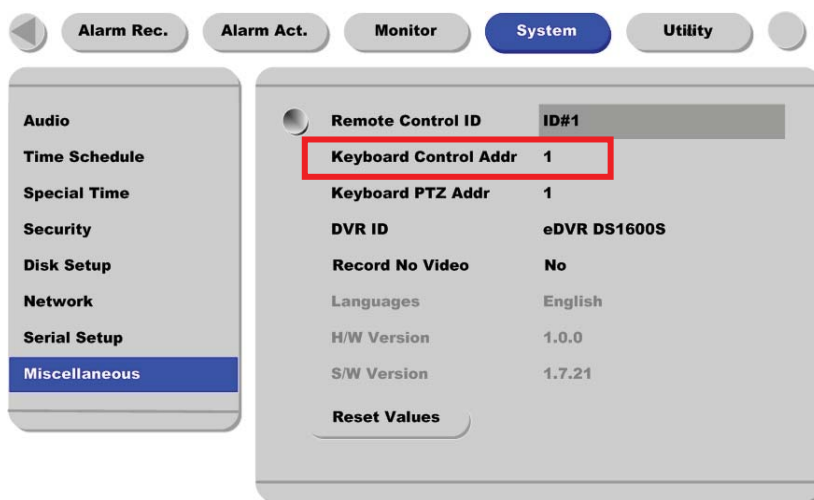

③ The value of 'Keyboard Control Addr' at [SYSTEM] -> [Miscellaneous] is configured in the order of 1, 2, 3, and 4.

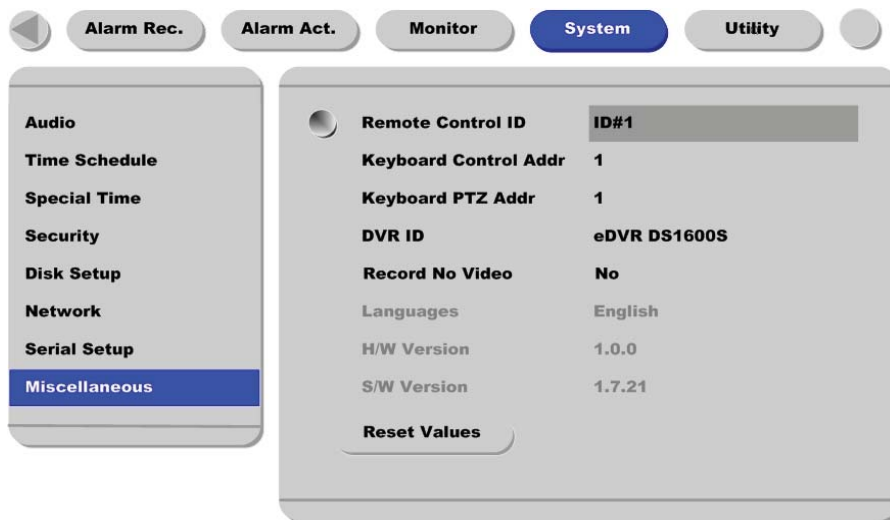

④ Configure COM port of the connected speed dome camera at [SYSTEM] -> [Serial Setup].

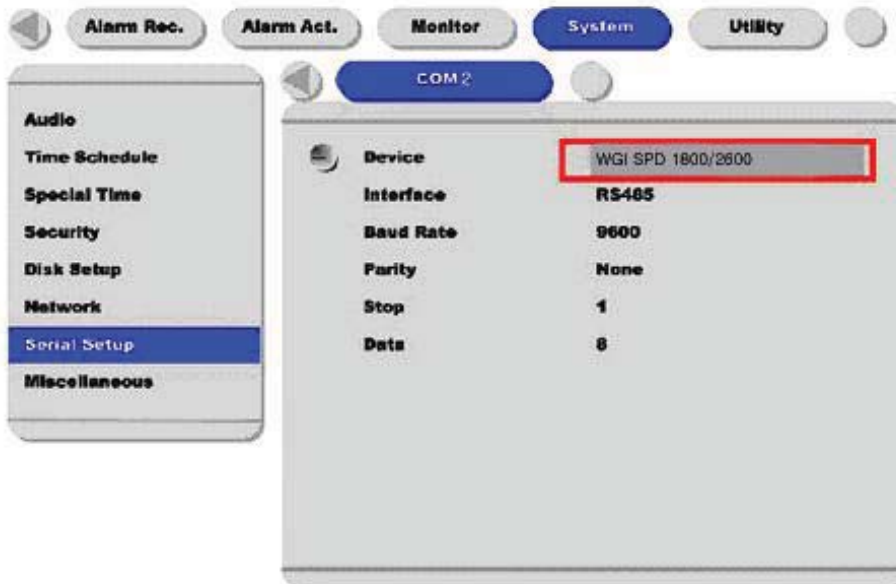

⑤ Configure COM port of the connected keyboard at [SYSTEM] -> [Serial Setup].

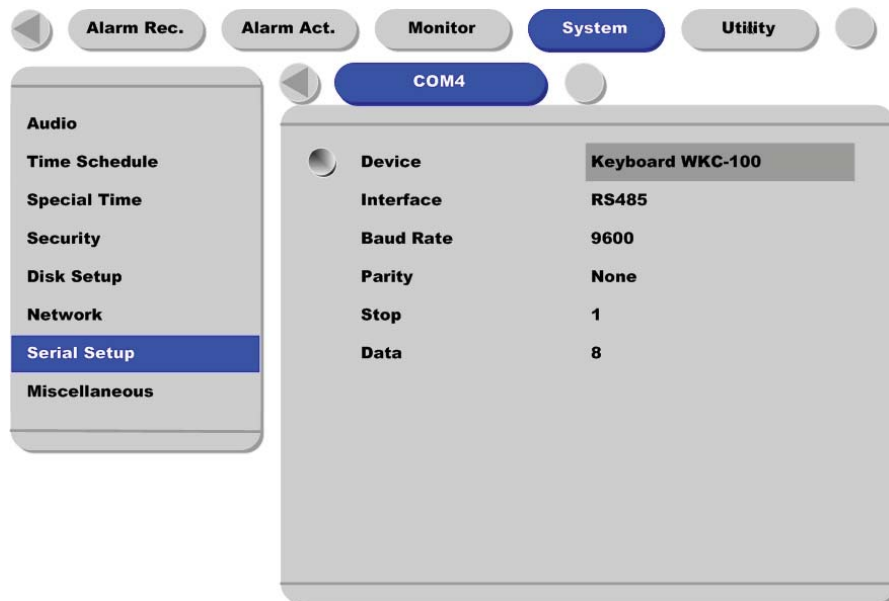

⑥ Configure PTZ port and address from the DVR channel connected at speed dome camera.

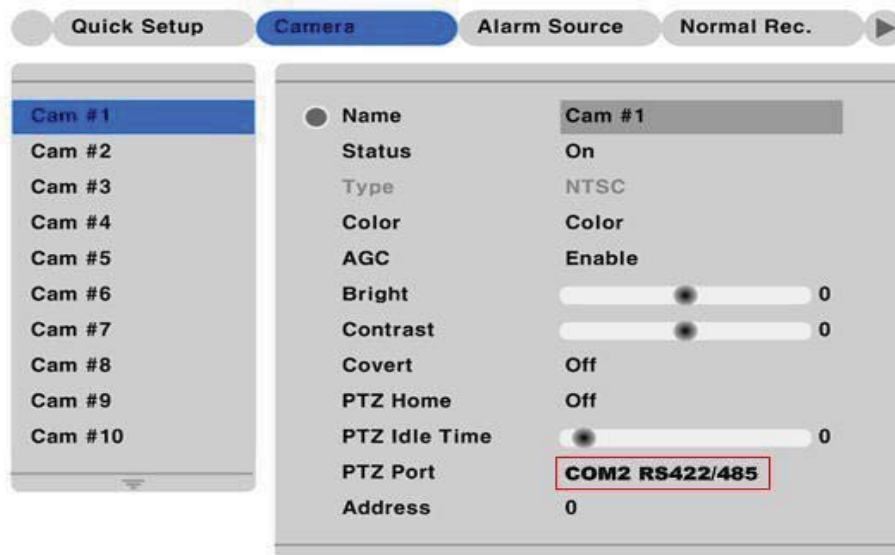

2.6.1.3. Installation between One Keyboard and Several DVRs

(1) Installation by Junction Box Jump

① Connection between Keyboard and Junction Box

Connect DATA1 port of keyboard to DATA1 port of junction box using direct cable.
Plug in 12V power supply at the junction box.
Any additional power supply is not necessary for keyboard.

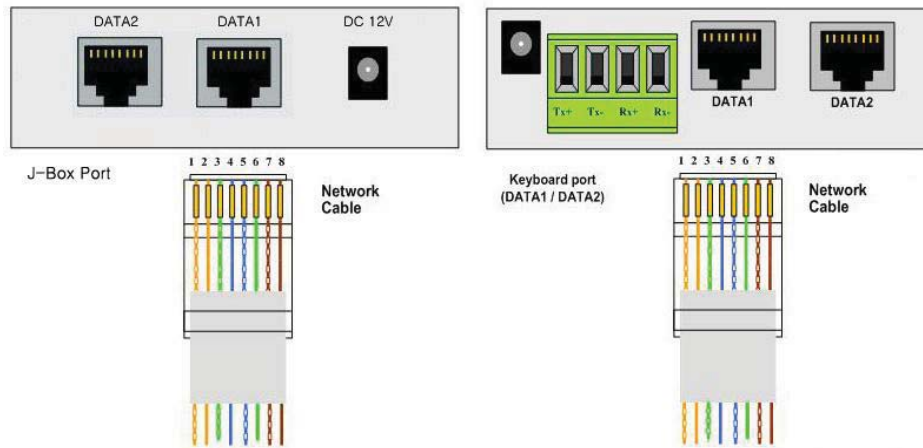

Connection between Keyboard and J-Box

② Connection between DVR and Junction Box

Connect COM2 port of DVR to +/- terminal of junction box, which is located at the 1st terminal from right side.

To install one keyboard with several DVRs, +/- terminal of junction box is connected to R+, R-terminal of each DVR by jumping.

* To connect to COM4 port, please follow the same way as above +/- terminal jumping of junction box and connect to COM4 port of DVR using RJ-45 cable.

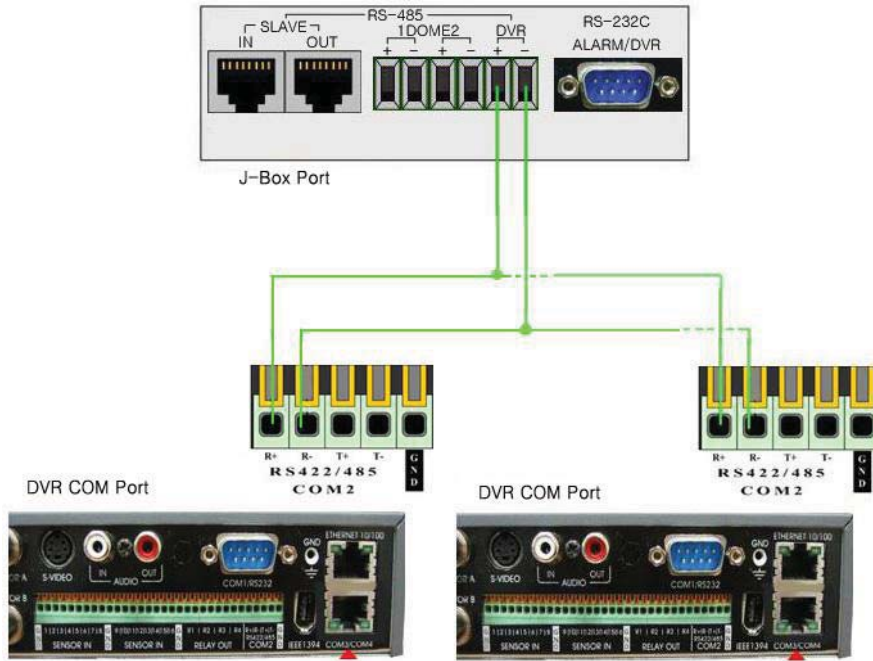

Connection between Several DVRs and One J-Box

③ Configure COM port of DVR shown as below figure.

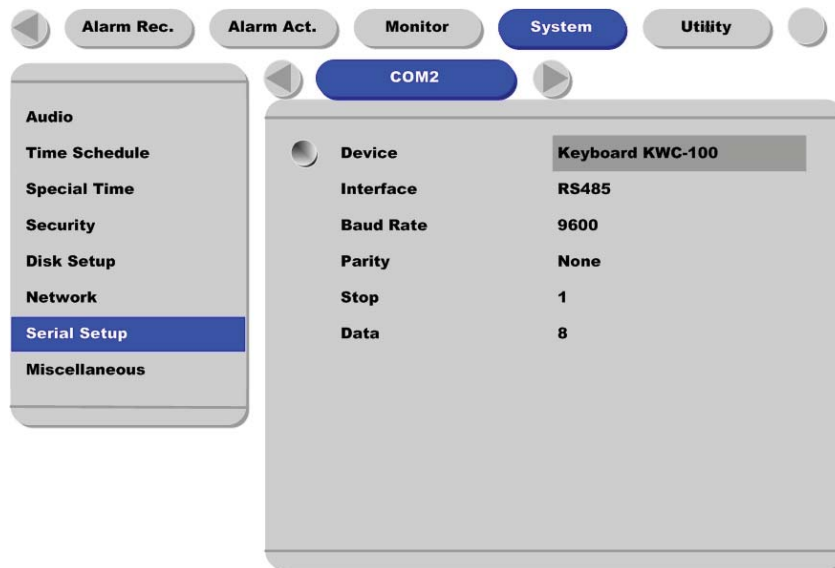

④ Configure 'Keyboard Control Addr' of DVR.

(The value is assigned differently by order of DVR. 1, 2, 3,...)

Configure 'Keyboard PTZ Addr' as '1'.

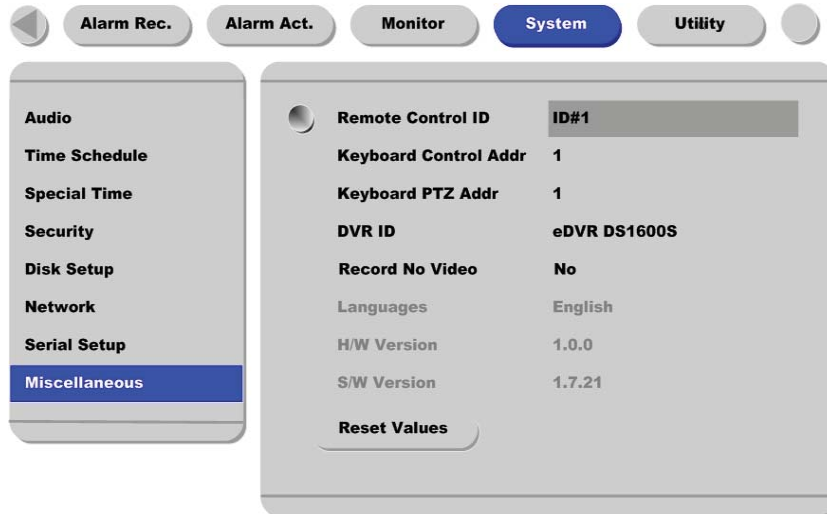

(2) Installation by Keyboard Bypass

① Connection between Keyboard and Junction Box

Connect DATA1 port of keyboard to DATA1 port of junction box using direct cable.

Plug in 12V power supply at the junction box.

Any additional power supply is not necessary for keyboard

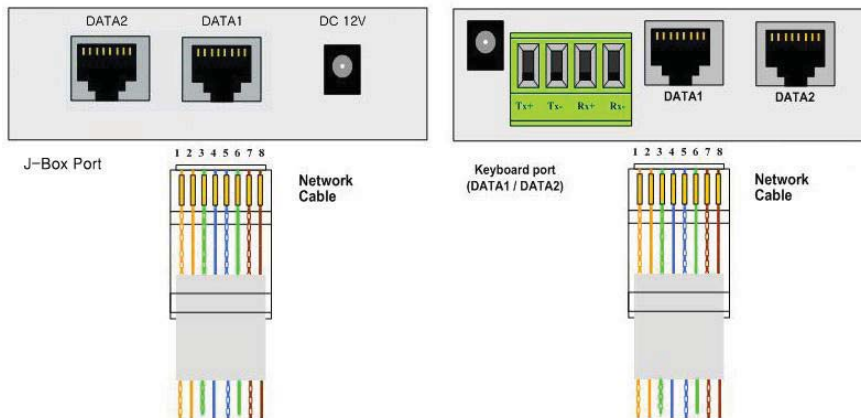

Connection between Keyboard and J-Box

② Connection between DVR and Junction Box

Connect COM4 port of DVR to +/- terminal of junction box.

* Please refer to  **How to Utilize Keyboard Pin-Map** at page 9 for more in detail.

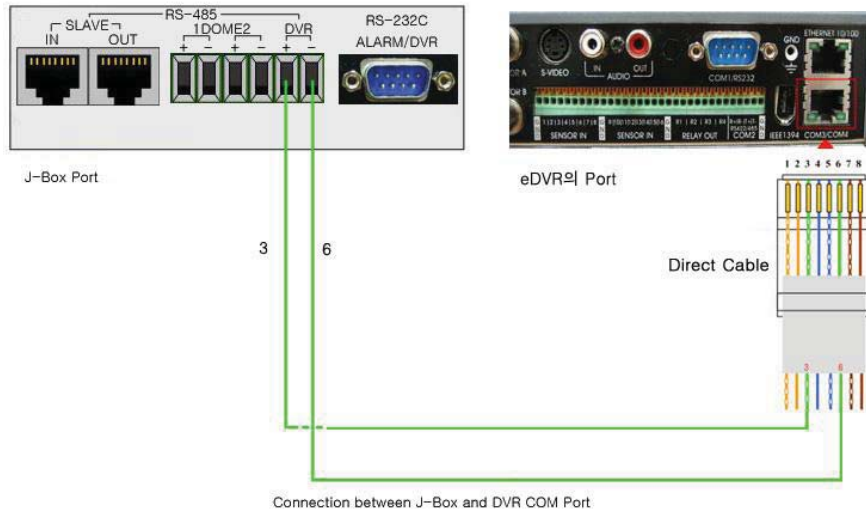

③ Connection between each DVR using Keyboard Bypass

Connect COM1 port of each DVR using RS-232 cable.

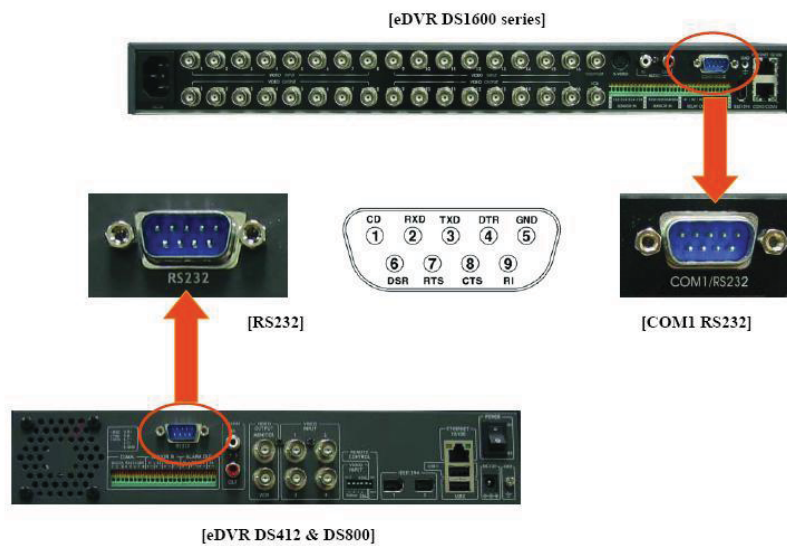

- ④ Configure COM port of DVR connected at junction and by keyboard bypass (RS-232 connection) box shown as below figure.

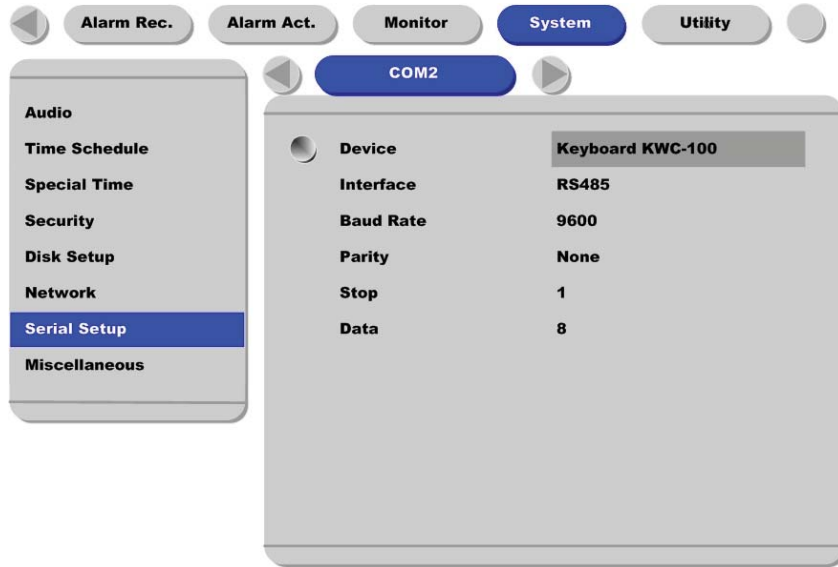

- ⑤ Configure COM1 port of DVR connected at the junction box shown as below figure.

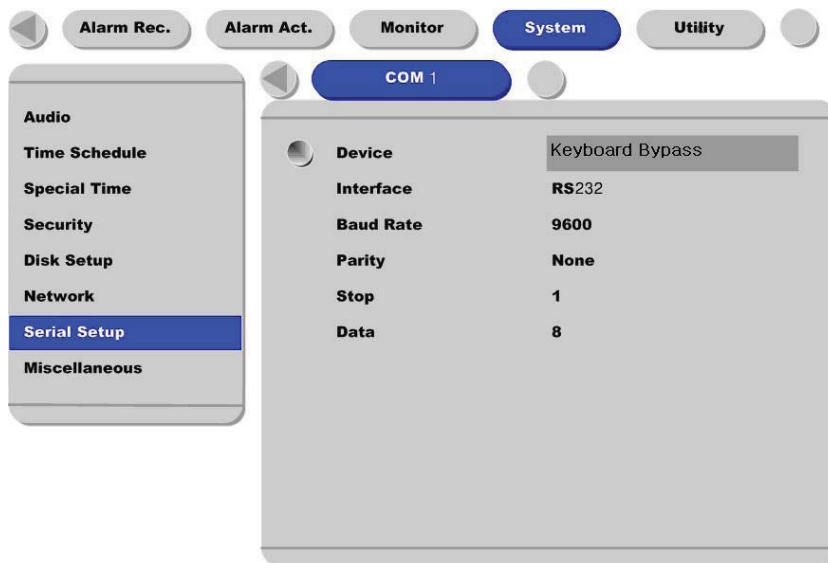

⑥ Configure 'Keyboard Control Addr' of each DVR.

(The value is assigned differently by order of DVR. 1, 2, 3,...)

Configure 'Keyboard PTZ Addr' as '1'.

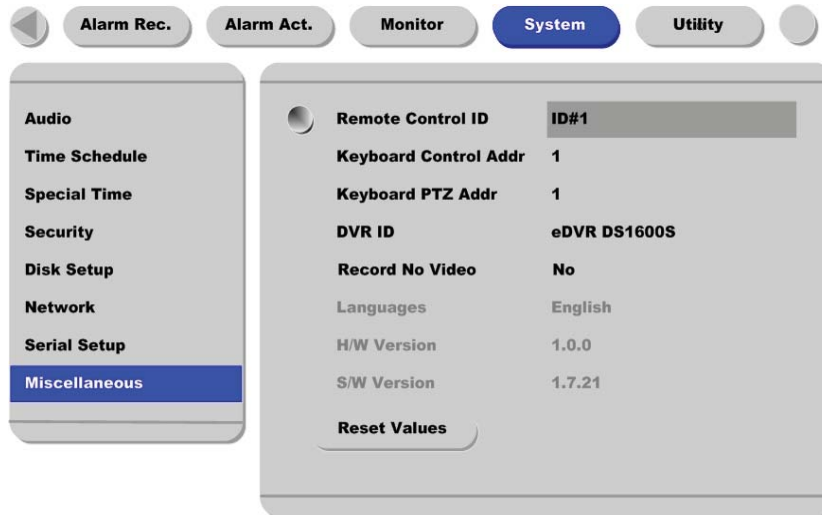

(3) Maximum DVR Configuration with one Keyboard

In case of installing maximum DVR with one keyboard, please follow the below figure.

- ① The maximum line of J-Box Jump is 4.
- ② The maximum Keyboard Bypass from J-Box Jump is 4.
- ③ According to the above ① & ②, the maximum 16 DVRs can be connected.

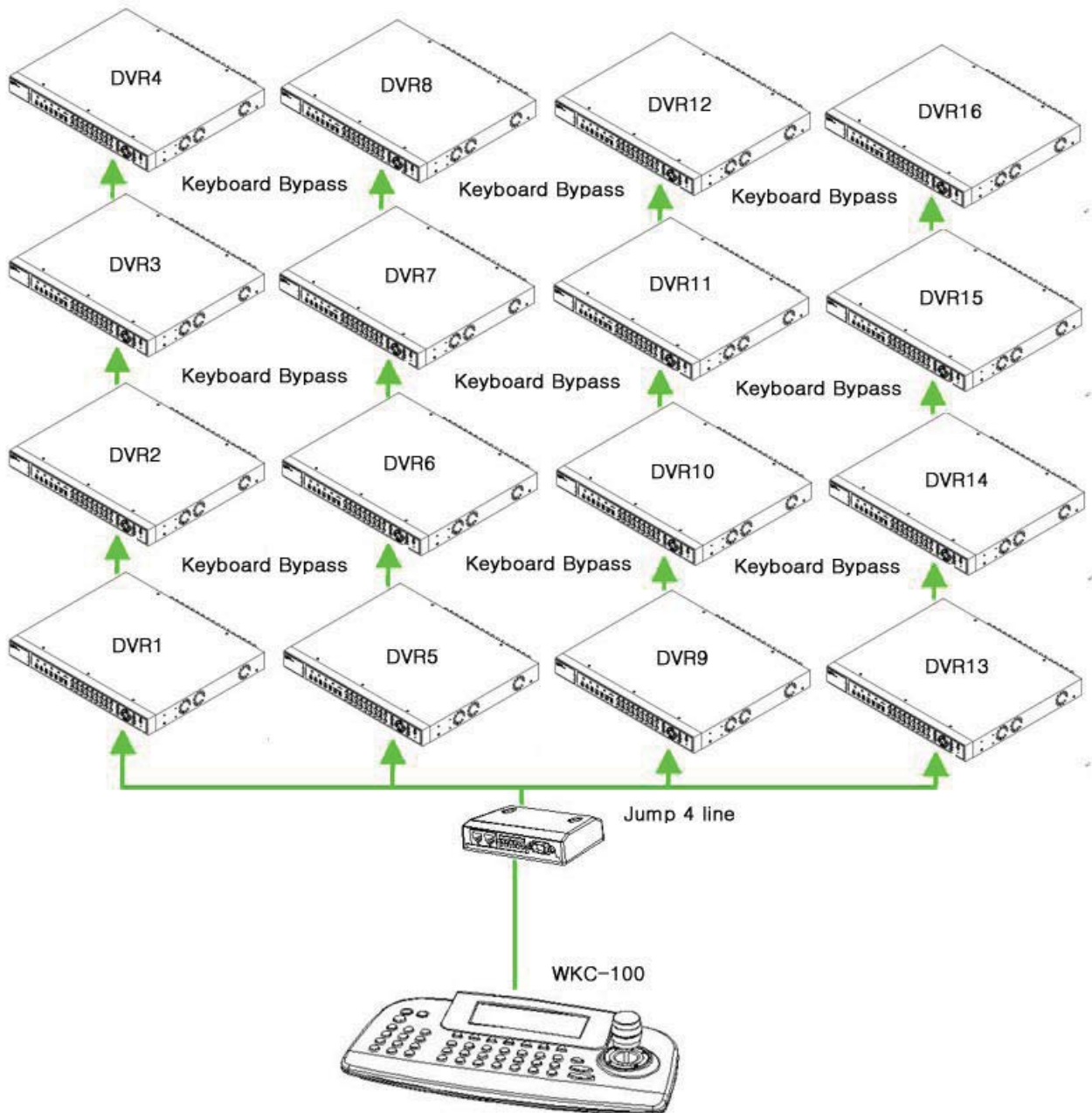

*Please contact to Webgate for connecting to over 16 DVRs

3. Keyboard Operation

This keyboard user guide describes 'DVR' mode only and please refer to the SPD1800&2600 user guide for 'SYS' mode. When power is on, keyboard automatically enters 'DVR' mode and displays 'DVR-0001" at the center of LCD screen. Pressing numeric key + 'SYS' goes to 'SYS' mode.

3.1. MENU KEY

Each function key is defined as below figures. Pressing 'F' key once, 1st, 2nd, 3rd functions are displayed in sequence at the LCD screen.

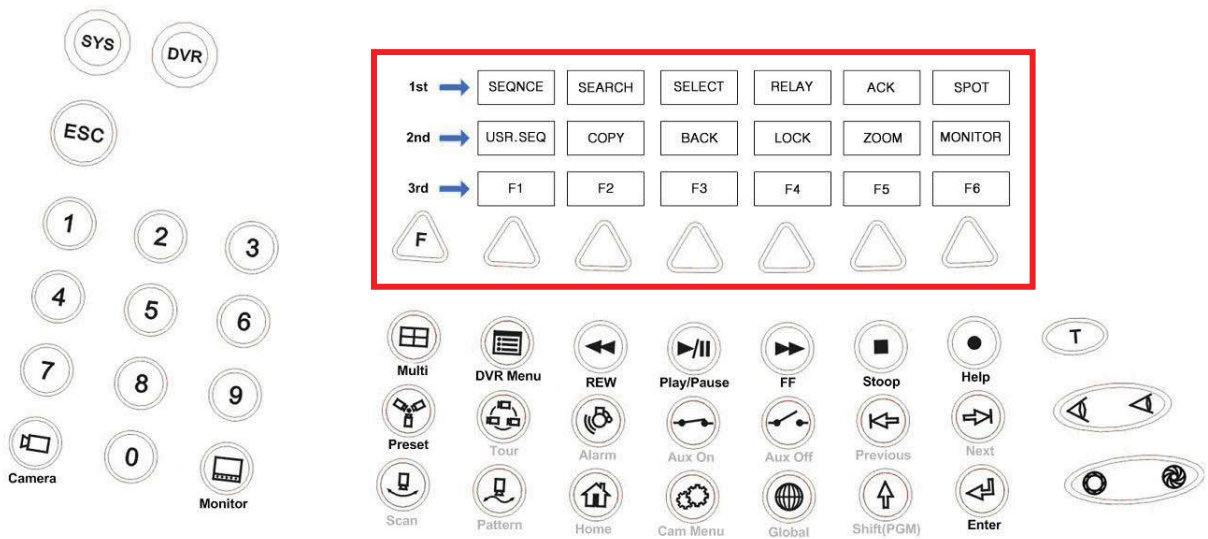



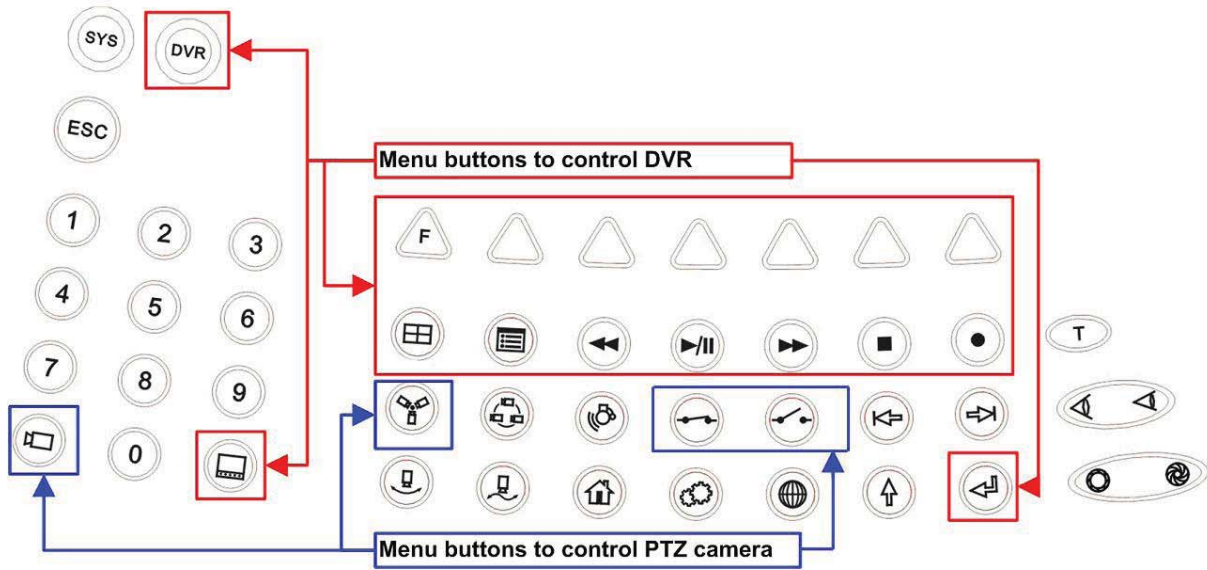

The keys in red box are for DVR configuration and in blue box for speed dome camera configuration.



3.2. DVR CONFIGURATION KEY

The keys to control DVR are as below and they function in the same way that identical buttons on the Webgate eDVR console do.

Key	Description
	DVR Control Mode (e.g. : 1 or 2 + DVR).
	Select a certain channel of DVR to display video on the main monitor Camera No. (1~16) + Main → Display the selected camera in a full screen monitor
	Sequential Switching
	Search Data
	Select Channel
	Relay On / Off
	Release Latched Alarm (For DS1600Q model only)
	Spot Monitor and Similar function as 'MONITOR' key (For DS1600Q model only)
	User-Defined Sequential Switching
	Copy Image
	Backup Data
	Lock the Keys on the console
	x2 Digital Zoom
	Select Monitor A or B (For DS1600Q model only)
	Reserved Key (Support on the next firmware)
	Multi-Screen Display
	Display console menu of DVR on the screen
	Rewind Button

	Play/Pause Button
	Forward Button
	Stop Button
	Help Key
	Enter Key

* The keys in gray-shad squares appear in turns when the triangle 'F' key is pressed.

** For detailed function of each DVR button, please refer to DVR user's guide.

◆ Select a DVR to control

- [Number Key] + [DVR Key]
- After this action, all the command sends to the selected DVR.
- E.g.)



◆ Select a video channel to display in a single-full screen mode

- [Number Key] + [Monitor Key]
- With this action, the selected channel displays video in a single-screen mode as well as reacts to PTZ control command
- E.g.)



◆ Set a number on DVR without changing display screen mode or PTZ control channel

- [Number Key] + [Enter Key]
- With this action, user may enter number to DVR menu
- E.g.)



◆ View a moment the selected channel using SPOT function

- [SPOT Key] + [Number Key] + [Monitor Key]
- With this action, user may enter number to DVR menu
- E.g.)



- ◆ View the selected channel of Monitor B
 - [LCD MON Key] + [Number Key] + [Monitor Key]
 - With this action, user may enter number to DVR menu
 - E.g.)





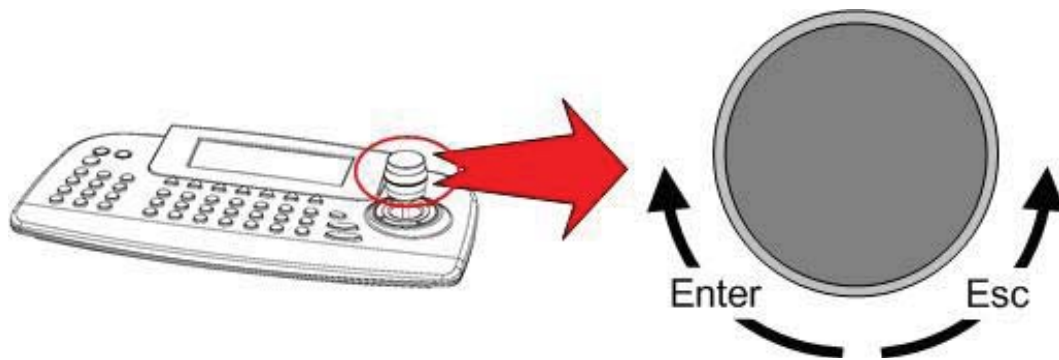





When configure DVR with its OSD menu, the joystick works as clockwise for 'Enter' and counterclockwise for 'Esc' buttons shown as below figure.
By controlling a joystick as Top/Bottom/Left/Right,



3.3. SPEED DOME CAMERA (PTZ) CONFIGURATION KEY

Even through below keys are to control speed dome cameras, the commands are delivered through the attached DVR.

Key	Description
	Select a camera channel to control PTZ
	Move a camera to a certain preset position
PGM 	Save current position as a certain preset
	Turn on the auxiliary function on DVR, which send special command to control PTZ camera
	Turn off the auxiliary function on DVR, which send special command to control PTZ camera
	Display menu of the speed dome camera
	Adjust a focus
	Adjust an Iris (Support limited PTZ only)

- ◆ Select a camera channel to control PTZ
 - [Number Key] + [Camera Key]
 - With this action, the selected camera channel reacts to PTZ control command by maintaining existing display screen mode
 - E.g.)



- ◆ Move camera to a certain preset
 - [Number Key] + [Preset Key]
 - With this action, the selected camera moves to the designated preset.
 - E.g.)







- ◆ Turn on / off the auxiliary function on DVR to make the selected camera perform the defined action.
 - [Number Key] + [Auxiliary On/Off Key]
 - With this action, the selected camera moves to the designated preset
 - For more information on utilizing Aux function on eDVR, please refer to the related manual.
 - E.g.)



3.4. KEYBOARD MENU OPERATION KEY

3.4.1. Basic Operation

The principle of joystick usage in the programming (editing) mode is shown as below table.

Button or Joystick Movement in Menu	Function
 Joystick Left or Right	Go into the sub-menu items Execute the command (exit) Change value Navigate through the menu items
 Joystick Up or Down	Navigate through the menu item
 Joystick Down	Finish editing title
 Zoom Handle Twist	Change value (Increase / Decrease) Enter editing title mode
 SHFT + Joystick	PTZ control mode
ESC	Escape from the menu without change
Home or Off Button	Delete value or name of the field

When the keyboard controller is powered on, password will be asked for access the keyboard controller.

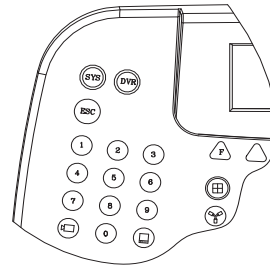
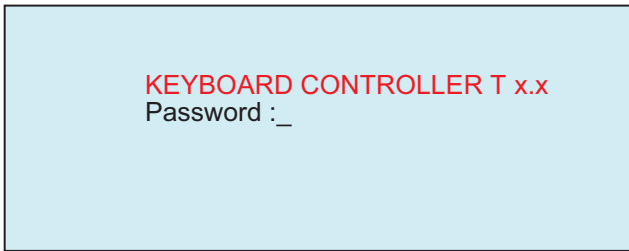

Unless changing password, 9999 is for administrator's password and 1111 for user.
If you forgot your own password, contact service personnel or distributor.

Press 9,9,9,9 and then consecutively. (9999+Enter)

The keyboard controller will display following screen and ready to control the dome cameras

Press key also will get back system mode from the DVR control mode.

LCD Display in system mode

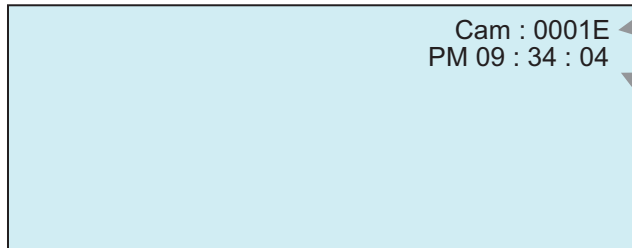

Camera ID

Date and Time

When you need to control DVR, please press key. LCD screen will be shown following DVR mode.

LCD Display in DVR mode 1

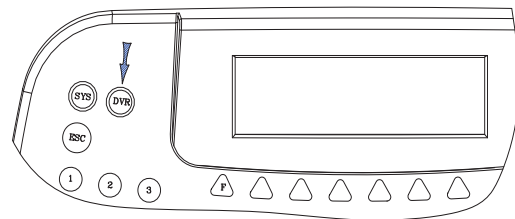
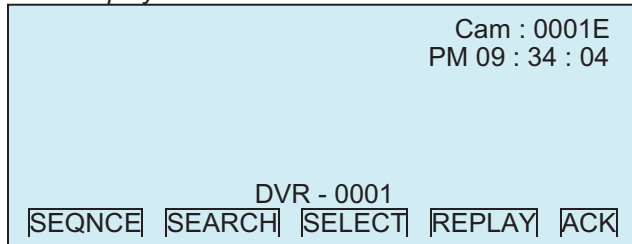

LCD Display in DVR mode 2

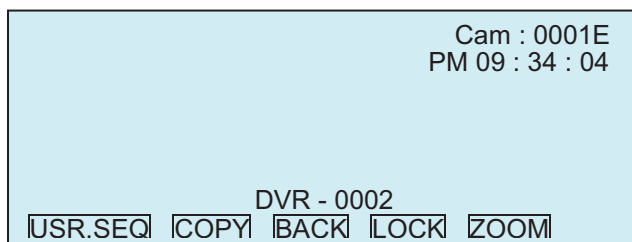

Pressing key, then it shows DVR mode 2.

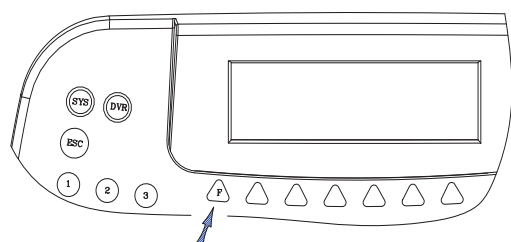

LCD Display in DVR mode 3

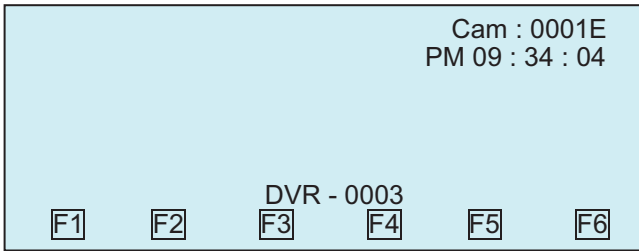

Press key again, then it shows DVR mode 3. Whenever pressed key, the DVR mode will be circulated.

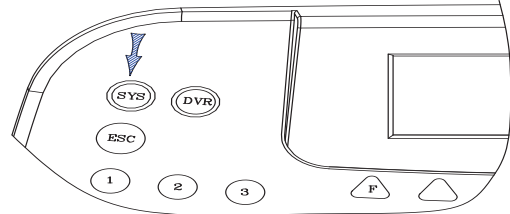

Press key to go back to the system mode from the DVR control mode.

3.4.2. Configuration

If user needs to setup the network, passwords and perform special tasks such as Uploading and Downloading programmed data from the dome cameras, hold down key, and then press key (**Shft + Menu.**) You will see the following main menu. Joystick Up/Down scrolls menu items, push the stick to Right to enter the sub menu.

MAIN MENU (+ = **Shft + Menu**)

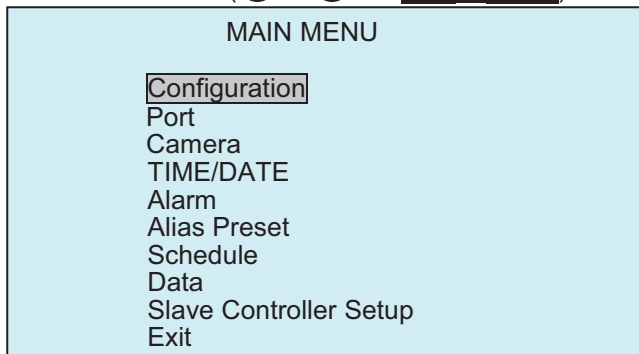

: Joystick push up and pull down, Navigate menu items

: Push the Joystick to the right to enter the sub menu

: Rotate CW (ClockWise) or CCW (CounterClockWise) increase or decrease the value in the item

: Same effect as zoom handle rotation

+ : Press and hold down key then press key

, : Press first key and then second key consecutively

CONFIGURATION (Shft + Menu → CONFIGURATION)

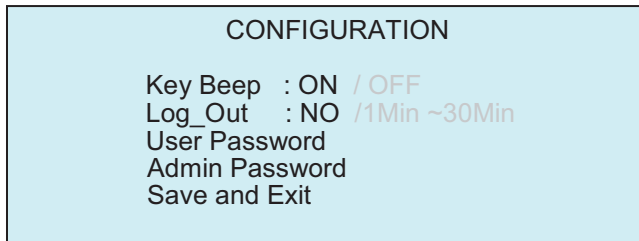

- Key Beep ON : Enable key beep sound
OFF : Disable key beep sound
 - Log_Out OFF~ 30Min : After elapsed setup time, keyboard locks automatically
OFF : Disable auto Key-Lock function
☞ User needs the login password again to operate the Keyboard
 - User Password → Simple operation (Not allowed changing setup or program)
Password : Enter 4 digit current user's password
New Password : Enter 4 digit new password
Confirm Password : Confirm 4 digit new password
 - Admin Password → Fully accessible menu and changing setup and program
Password : Enter 4 digit current user's password
New Password : Enter 4 digit new password
Confirm Password : Confirm 4 digit new password
- Note) Factory default Administrator's password is 9999+Enter and user password is 1111+Enter.
If you forgot your own password, please contact service personnel or distributor.*
- Save and Exit → Save the programmed data and return to the previous Menu
(Exit without saving if you press **ESC** key)

PORT (Shft + Menu → PORT SETUP MENU)

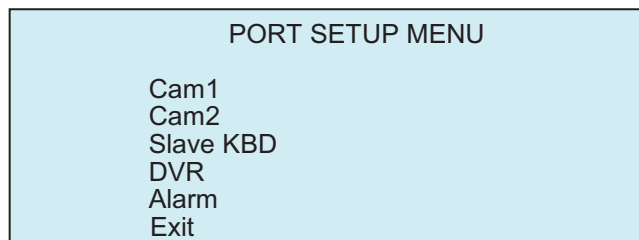

Cam1 (Shft + Menu → PORT SETUP MENU → Cam1)

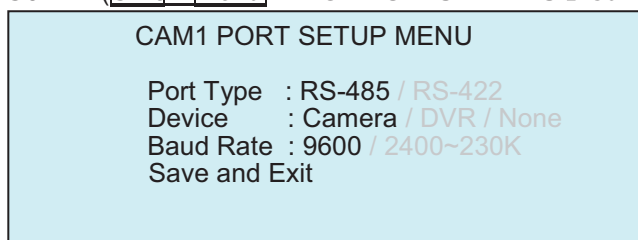

- Port Type : Configure Port as RS-485 or RS-422
- Device : Select Device to be controlled (Camera / DVR / None)
- Baud Rate : Communication speed (2400/ 4800/ 9600/19200/ 38400/ 57600/ 11.5K /230K)
- Save and Exit : Press **ESC** key to exit without saving the data.

Cam2 (Shift + Menu → PORT SETUP MENU → Cam2)



Device : Select Device to be controlled (Camera / None)
Baud Rate : Communication speed (2400/ 4800/ 9600/19200/ 38400/ 57600/ 11.5K /230K)
Save and Exit : Press **ESC** key to exit without saving the data.

Slave KBD (Shift + Menu → PORT SETUP MENU → Slave KBD)

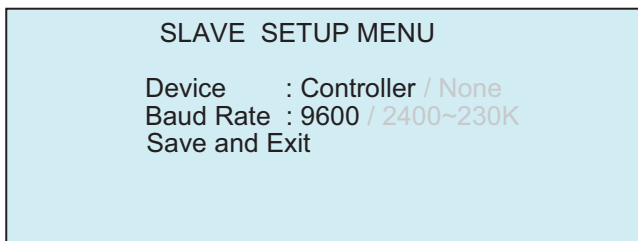

Device : Select Device to be controlled (Controller / None)
Baud Rate : Communication speed (2400/ 4800/ 9600/19200/ 38400/ 57600/ 11.5K /230K)
Save and Exit : Press **ESC** key to exit without saving the data.

DVR (Shift + Menu → PORT SETUP MENU → DVR)



Device : Select device to be controlled (DVR / Alarm / AUX IN / AUX IO /None)
Baud Rate : Communication Speed (2400/ 4800/ 9600/19200/ 38400/ 57600/ 11.5K /230K)
Save and Exit : Press **ESC** key to exit without saving the data

ALARM (Shift + Menu → PORT SETUP MENU → Alarm)

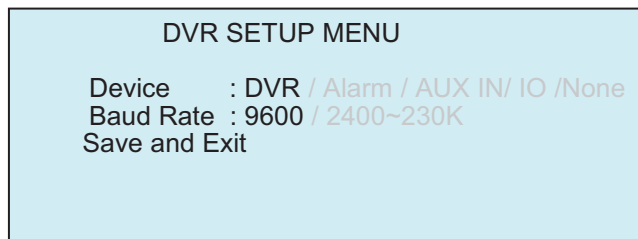

Device : Select device to be controlled (DVR / Alarm / AUX IN / AUX IO /None)
Baud Rate : Communication Speed (2400/ 4800/ 9600/19200/ 38400/ 57600/ 11.5K /230K)
Save and Exit : Press **ESC** key to exit without saving the data

Camera (**Shft** + **Menu** → Camera)

CAMERA SETUP					PAGE : 001
Cam	Protocol	Port	B_rate	Alarm	
0001	RVT	PORT 1	9600	OFF	
0002	RVT	PORT 1	9600	OFF	
0009	- -	- -	9600	OFF	
----	- -	- -	9600	OFF	
3999	RVT	PORT 1	9600	OFF	
OFF :del					ENTER : save & exit
					ESC : cancel

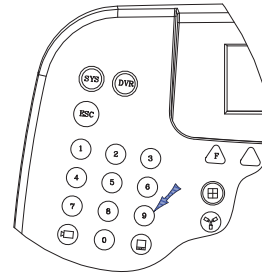

Press **No.** key or twist zoom handle on the first column to enter setup mode.

Input camera ID using number keys or twist the zoom handle to increase/ decrease the ID.

Push the joystick to the **Right/ Left** to select next/ previous item and select the protocol (**RVT/ S/ S2e/ P/ D**)

Push the stick to right and set the baud rate by twisting zoom handle.

Select whether receiving alarm is from the dome or not (Alarm OFF : simplex, Alarm ON : half-duplex).

Press **OFF** key to delete the dome ID and press **ENTER** key to save & exit.

Press **ESC** key to exit without saving.

Time/Date (**Shft** + **Menu** → Time/Date)

TIME / DATE Setup	
Display	: ON / OFF
Date Format	: Asia / US/ EURO 2005/JAN /18
Time Format	: 12 / 24 08: 59 : 04
Day Light Saving	: ON/ OFF
Day Light Saving	
Save and Exit	

Day Light Saving (**Shft** + **Menu** → Time/Date → Day light Saving)

Day Light Saving Setup		
Display	: ON / OFF	
	Date	Time
Start	: 01 / 01	00 : 00
END	: 01 / 01	00 : 00
Save and Exit		

Select Day Light Saving item and program the start and end date.

Push the joystick to Right/ Left to select item and twist the zoom handle for the date and time setting.

Alarm Menu (**Shft** + **Menu** → Alarm)

ALARM MENU	
Alarm Beep	: ON / OFF
Alarm Dwell	: OFF / 1sec~200sec
Alarm Action	
Alarm History	
Save and Exit	

- Alarm Beep : Enable or disable the beep sound when there is alarm activated.

- Alarm Dwell : Instant alarm will be extended until programmed time.

Alarm Schedule (**Shft** + **Menu**) → Alarm → Alarm Action)

ALARM	SCHEDULE			page : 001
DOME	1	2	3	Alias
0001	1	2	3	999
----	-	-	-	-
----	-	-	-	-
----	-	-	-	-
----	-	-	-	-
ON : ins	OFF : del		SHIFT: ESC	

DOME : ID of the dome to be programmed. Ex) 0001
 Alarm : 8 Alarm inputs of dome (Alarm 4, 5 is not used).
 OUT : 999 external dry contact outputs.
 Alias : 999 alias presets. See Alias Preset menu.

☞ Please refer to **Alias Preset** menu.

If there is an alarm from the programmed dome, signal can be out to one of 999 external dry contact outputs. Also, combined with multiple dome presets will be called if programmed.

500 alarm schedules can be stored in this joystick controller.

Push Up/ Down the joystick will scroll previous/ next page on the first/ last row.

Twisting the zoom handle on the camera ID field to enter program mode and select ID. Rotating the handle, the programmed IDs (programmed in camera setup menu), will be scrolled.

Push the joystick to the right to setup alarm field. Activate or deactivate specific alarm inputs by rotating the zoom handle. And then program the rest of the part (Alarm input and output, Alias).

Alarm History (**Shft** + **Menu**) → Alarm → Alarm History)

ALARM	HISTORY		page : 0001
CAM	Alarm	Date	Time
----	-----	-----	-----
----	-----	-----	-----
----	-----	-----	-----
----	-----	-----	-----
OFF : clear history			ESC: exit

This screen shows up to 5000 history of the alarms activated previously.

Alias Preset Menu (**Shft** + **Menu**) → Alias Preset)

Alias	Preset	Menu	page : 0001
No.	Dome 1	Dome 2	Dome
----	----	----	----
----	----	----	----
----	----	----	----
----	----	----	----
OFF : del	Alarm : exe	ESC: exit	

Schedule (**Shft** + **Menu** , V, V, V → Schedule)

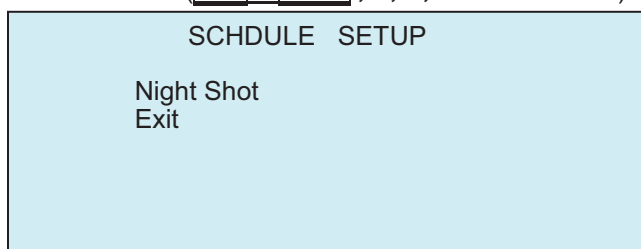

V V V : Push down the joystick until appears Schedule, the push to the right to enter the SCHEDULE setup menu.
(See page 39 MAIN MENU screen)

Night Shot (**Shft** + **Menu** → Schedul → Night Shot)

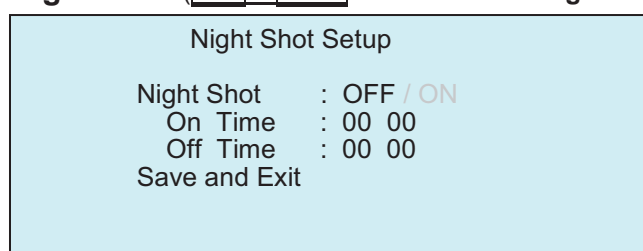

Night shot option is enabled or disabled with .

On Time and Off Time can be setup with .

Night shot enable option changes low light sensitivity by removing IR cut filter from the camera lens and Controller sends control command to all the cameras attached on the control line.

 999/888+ (888+Global : Night shot off  999+Global)

Data (**Shft** + **Menu** , V, V, V → Data)

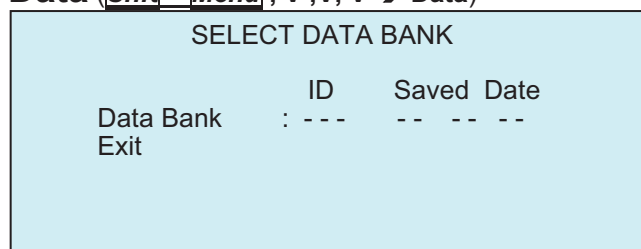

Slave Controller Setup (**Shft** + **Menu** , V, V, V → Slave Controller Setup)

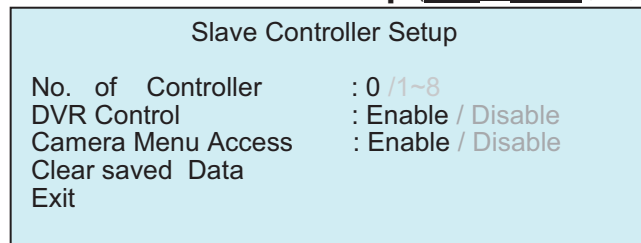

No. of Controller : 0,1~8 → Total No. of slave controller

DVR Control : Allow DVR control in the Slave controller.

Camera Menu Access : Allow camera menu in the Slave controller.

Clear saved Data : Clear all data in the Slave controller.

3.4.3. Operation

3.4.3.1. Selection of dome camera (Dome Camera ID)

There are three way of dome camera selection [(1) , () and () (Next) or (Prev) ()]
With these selections, the keyboard controller has the full control of the selected dome camera.

3.4.3.2. Selection of DVR (DVR ID)

DVR must be selected before controlled by joystick controller.
Press Number button and (DVR) button to change DVR ID to be controlled

<ex 1> Selection DVR ID #3
Press numeric (3) then (DVR) button on the controller, DVR-003 will be displayed on LCD window.

<ex 2> Selection DVR ID # 73
Press (7) and (3) then (DVR) button, DVR-073 will be displayed on LCD window.

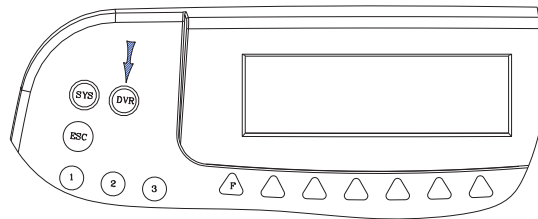

Global CCTV

Suite 1 (upstairs), 24 Hammond Rd Cockburn WA 6164

AUSTRALIA

Tel : +61 8 9417 1767

eMail : info@globalcctv.com.au

